

“Ένα κάθετο χωριό στο
Grenfell Tower”

Διπλωματική εργασία :
Κατερίνα Κοκκινοπλίτη
Κούκου Στεφανία

Επιβλέποντες καθηγητές:
Σταύρος Δενδρινός
Μαρία Α. Παναγιώταρου
Μαρία-Στυλιανή Βουτετάκη



Τμήμα Αρχιτεκτόνων Μηχανικών
Δημοκρίτειου Πανεπιστημίου Θράκης

Ξάνθη 2021







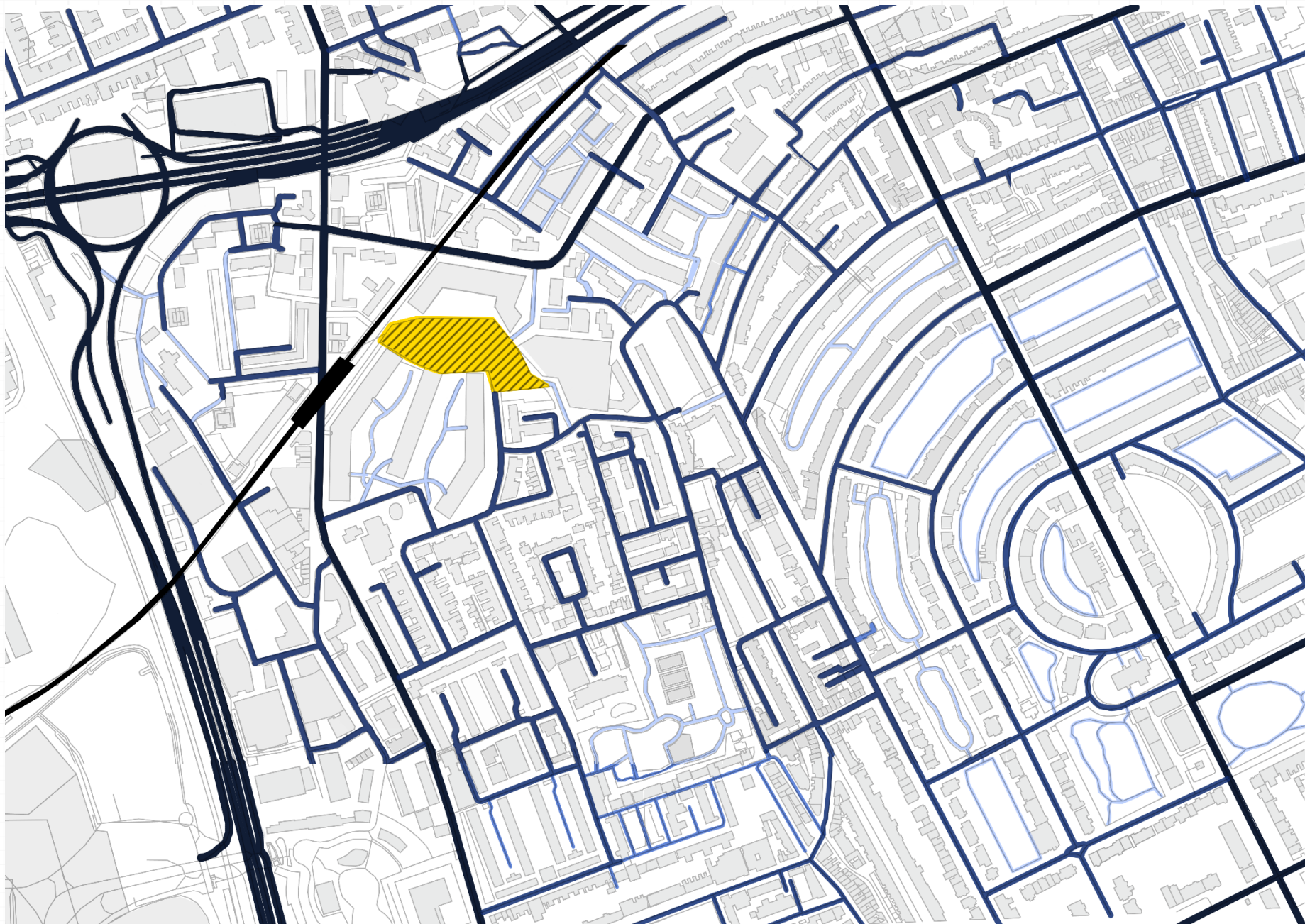

περιοχή

A vertical village in Grenfell Tower







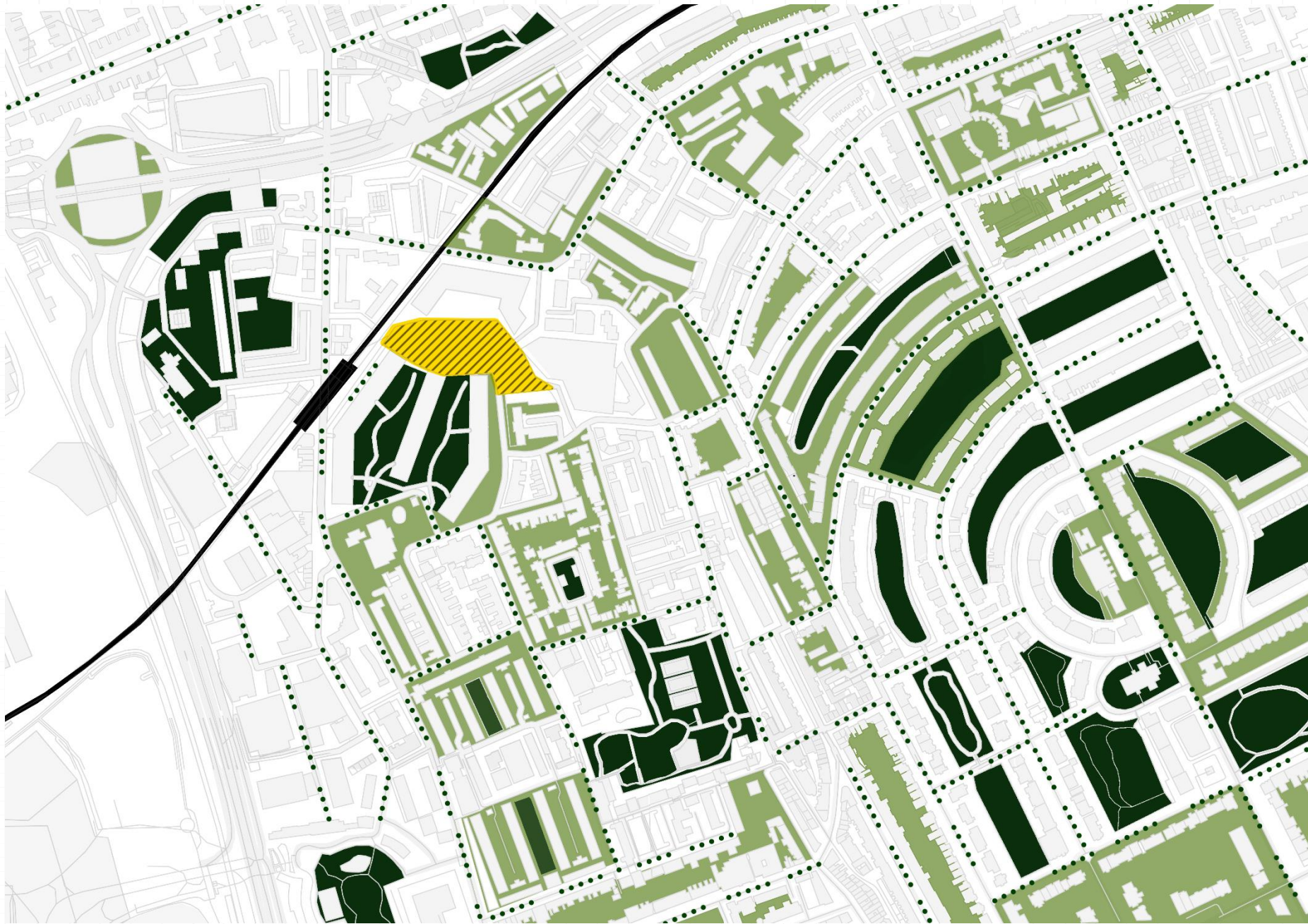

υπόμνημα.

-  Περιοχή Μελέτης
-  Μετρό Λονδίνου
-  Περιφερειακό Οδικό Δίκτυο
-  Πρωτεύον Οδικό Δίκτυο
-  Δευτερεύον Οδικό Δίκτυο
-  Πεζόδρομοι - Μονοπάτια





υπόμνημα.

-  Περιοχή Μελέτης
-  Μετρό Λονδίνου
-  Οργανωμένες Πλατείες - Πάρκα
-  Νησίδες – Πλατώματα Γειτονιάς
-  Δεντροστοιχίες



υπόμνημα.

-  Περιοχή Μελέτης
-  Μετρό Λονδίνου
-  Κατοικίες
-  Apartment Blocks
-  Σχολεία
-  Χώροι Πολιτιστικού Ενδιαφέροντος
-  Τοπικό Εμπόριο
-  Αθλητισμός
-  Χώροι Λατρείας
-  Τράπεζες
-  Ξενοδοχεία
-  Υπερμάρτιο
-  Πάρκα - Πλατείες





μορφολογία

A vertical village in Grenfell Tower

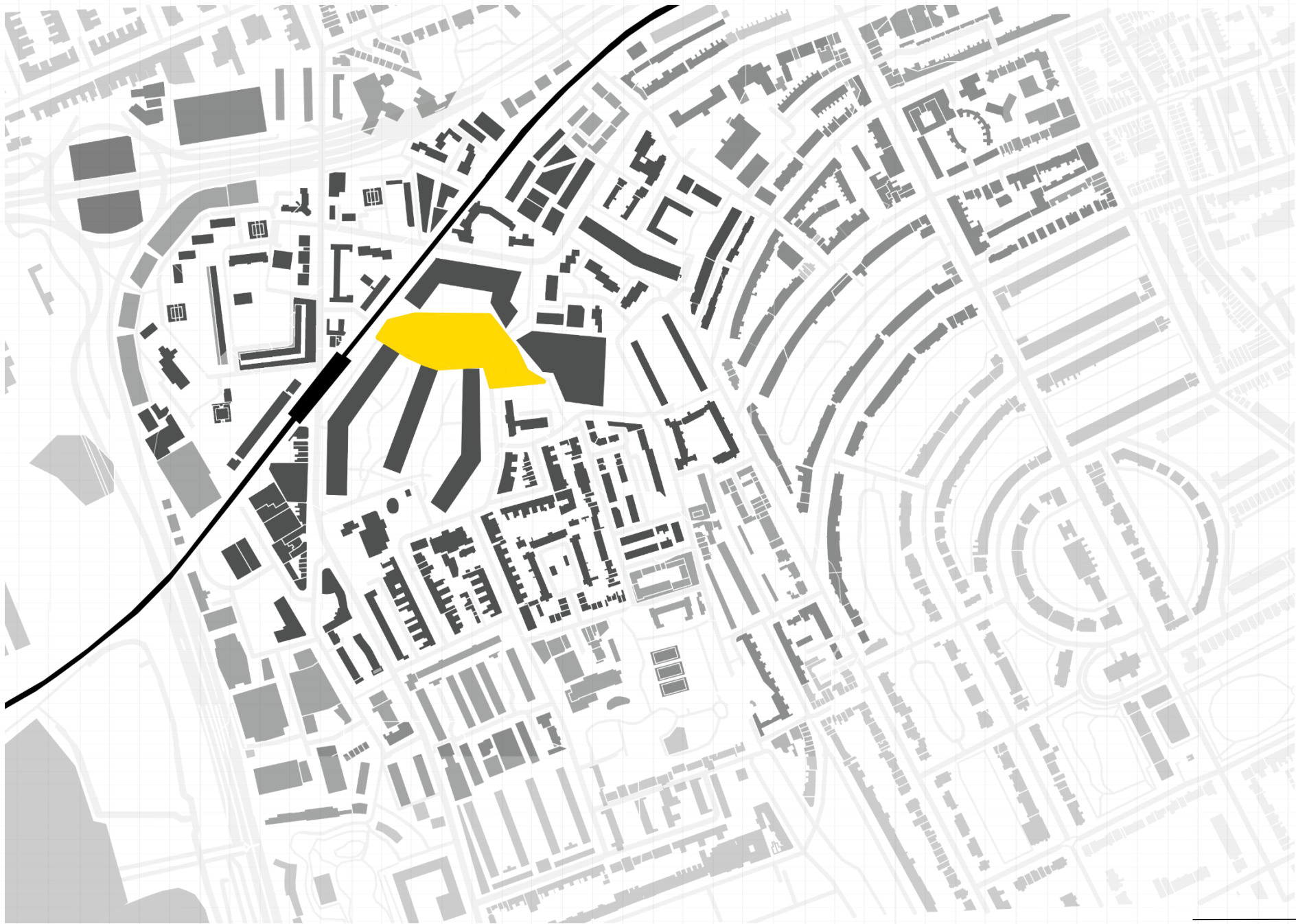



παρατηρήσεις.

- επιρροή της περιοχής από τον σταθμό
- μη συγκεκριμένο μοτίβο δόμησης
- ποικιλία στα ύψη των κτιρίων



blenheim crescent



calderon road



portland road



holland park



pembridge place



barbican towers



brenford towers



edward woods estate



trellick tower



darfiled way towers

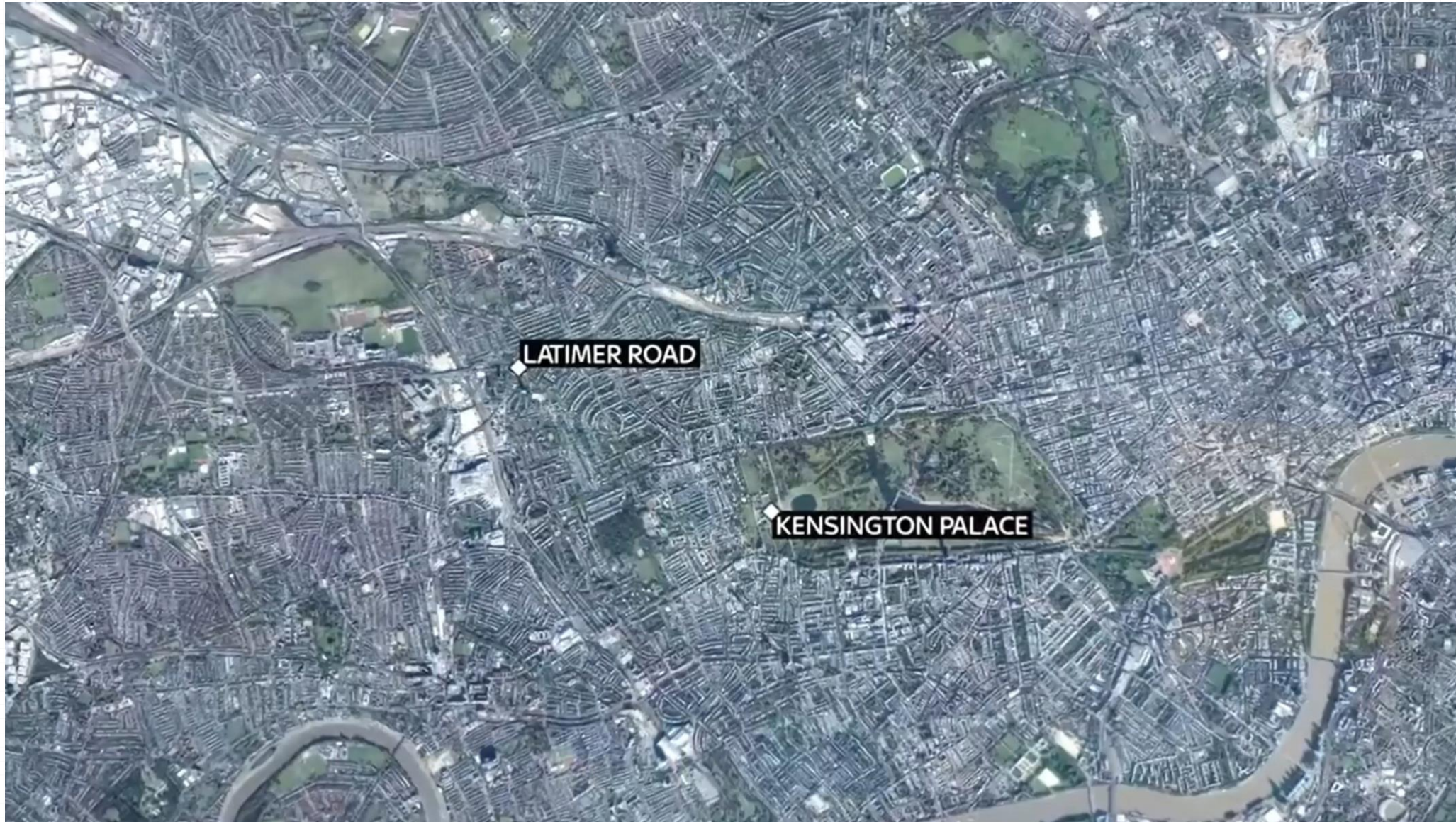

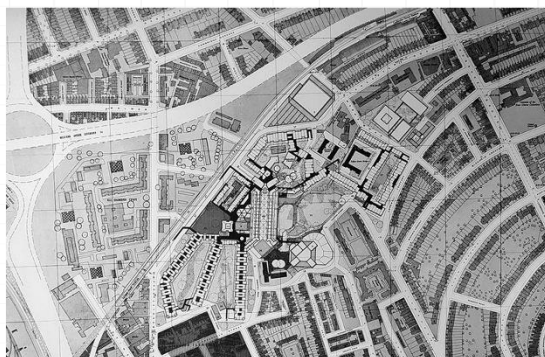

αρχικό master plan 1968



master plan του core project 2010

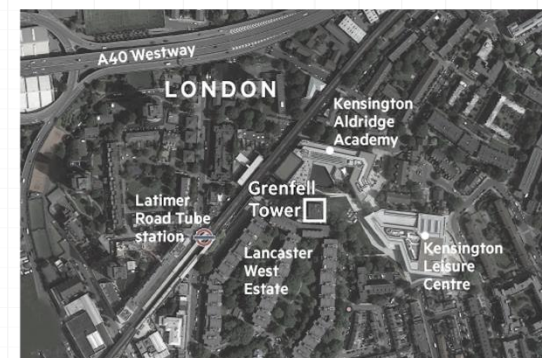

η περιοχή μετά την ολοκλήρωση του KALC project

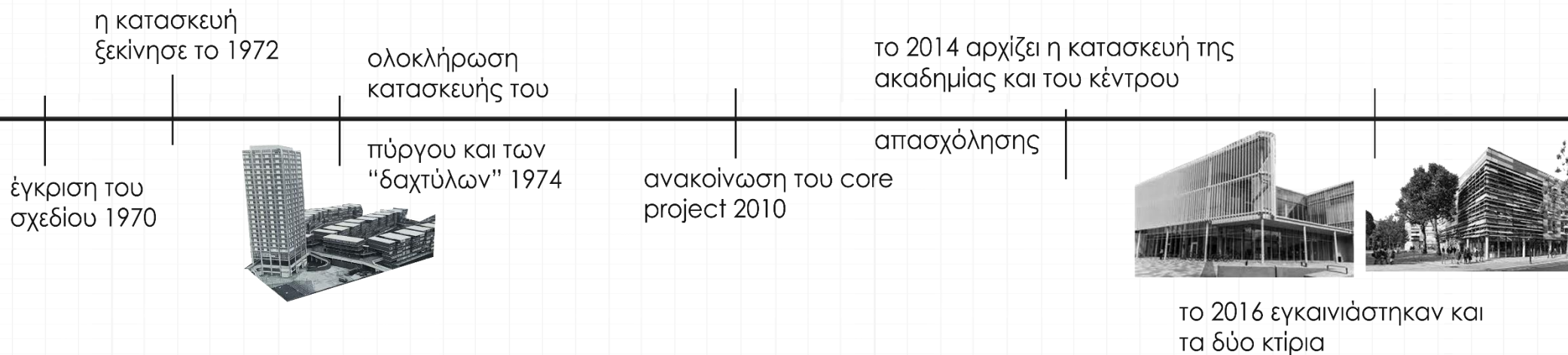

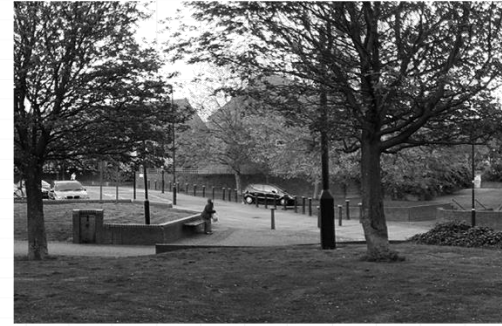

1. latimer road station

2. lancaster west

3. kenshington leisure center

4. lancaster green

5. aldrige academy

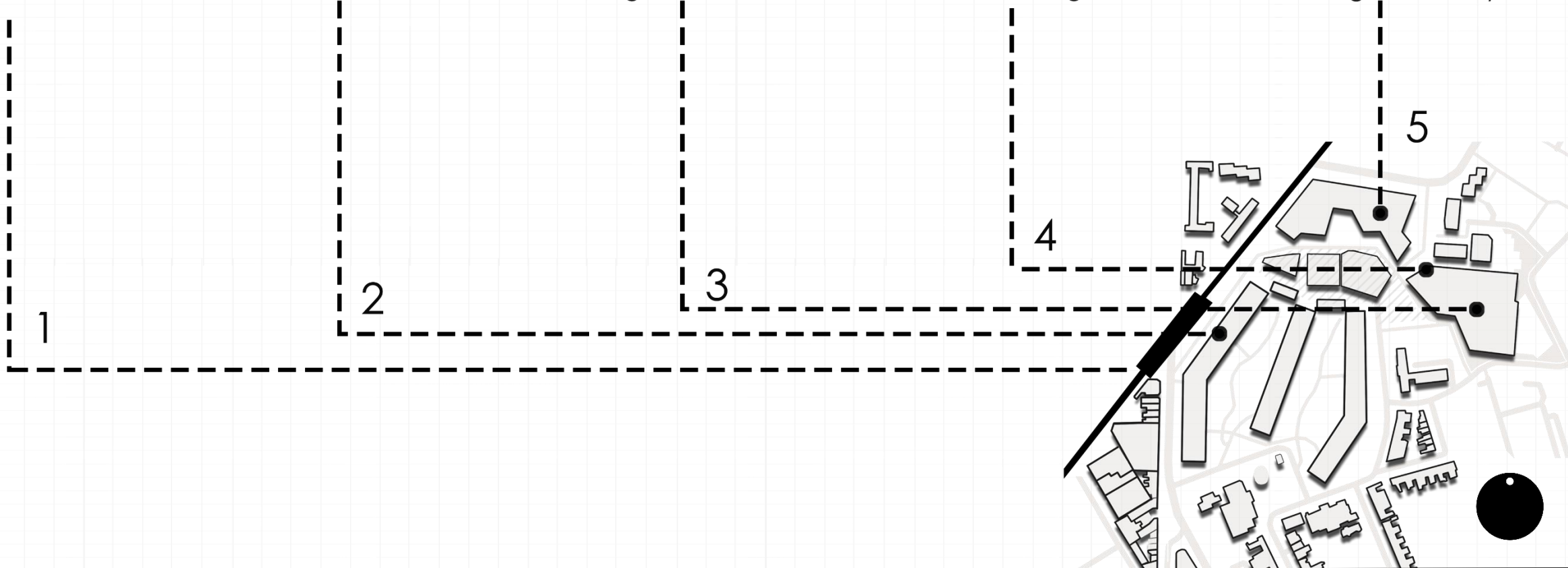



η κατασκευή ξεκίνησε το 1972



το κτίριο ολοκληρώθηκε το 1974

ενώ το 1990 πραγματοποιούνται επισκευές

το κτίριο ανακαινίζεται από το 2015-2016



Η φωτιά ξέσπασε στις 14 Ιουνίου του 2017

GRENFELL FOREVER IN OUR HEARTS

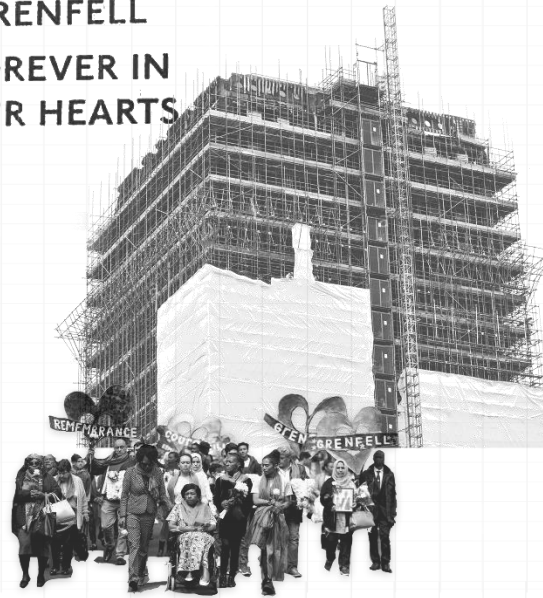

Τον Οκτώβριο του 2017 τοποθετούνται σκαλωσιές από τις οποίες κρεμιούνται λευκά πανιά που σκεπάζουν την καμένη όψη του κτιρίου.



Ο πύργος παραμένει καλυμμένος από τότε

ενώ γίνονται προσπάθειες για να γίνει μνημείο για τα



concept

A vertical village in Grenfell Tower

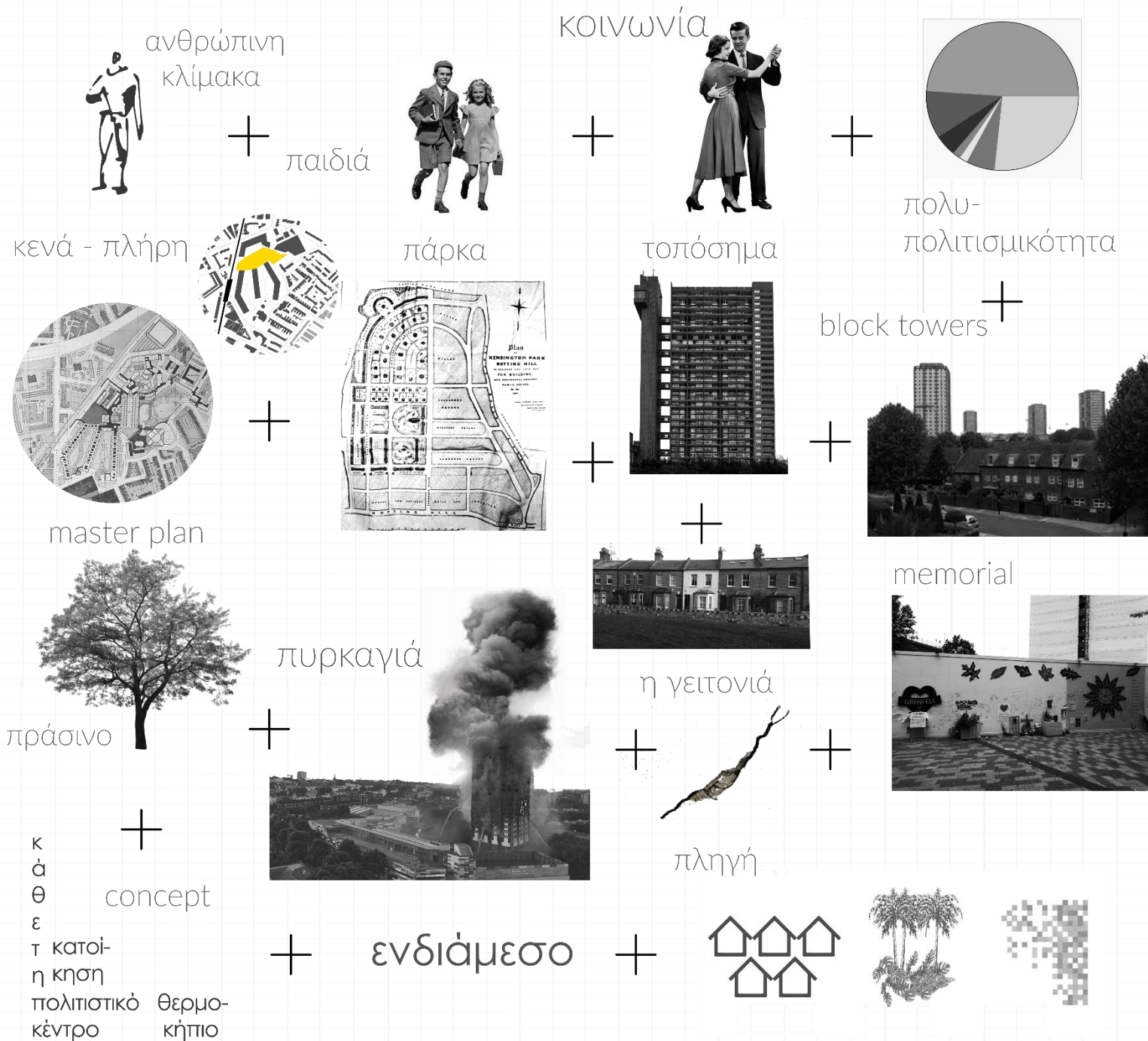

βασικά στοιχεία.

- κοινότητα / διαδραστικότητα μεταξύ των κατοίκων + κοινωνικοποίηση
- πράσινο / βελτιστοποίηση της ποιότητας ζωής + άνετο κλίμα
- προσβασιμότητα / ποικίλες εισοδοι στο οικόπεδο
- κατοικία / πάνω από το επίπεδο του δρόμου + διάφοροι τύποι διαμερισμάτων



Είσοδος από τον σταθμό του μετρό.

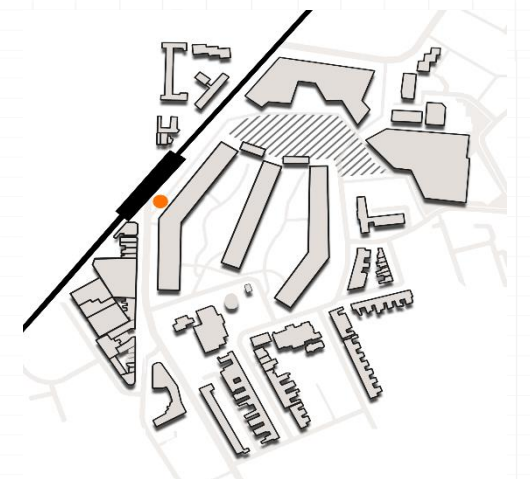



Είσοδος από τον σταθμό του μετρό και χρήση της υπάρχουσας ράμπας.





Είσοδος μέσα
από το γειτονικό κτιριακό συγκρότημα.

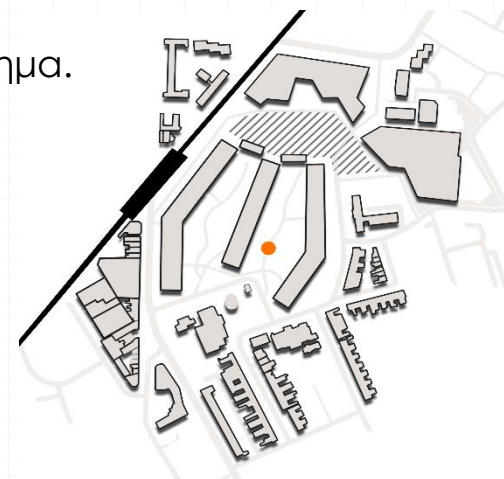



Είσοδος από τα ανατολικά
του κτιριακού συγκροτήματος 'fingers'.

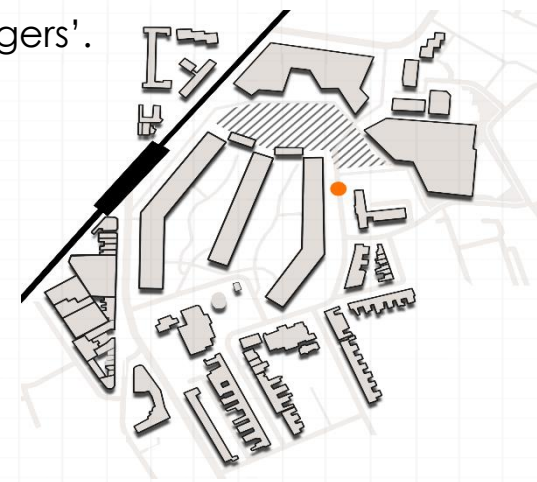



Είσοδος από τα ανατολικά
του κτιριακού συγκροτήματος 'fingers'.

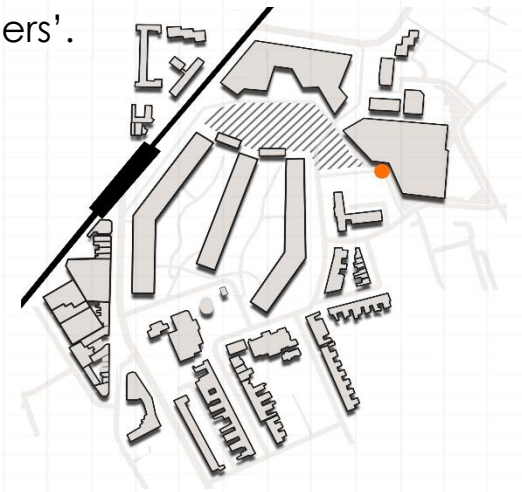



Χρήση κλειστής εισόδου που βρίσκεται ανάμεσα στο σχολείο και στο κέντρο απασχόλησης ως κεντρική είσοδος στο θέμα.

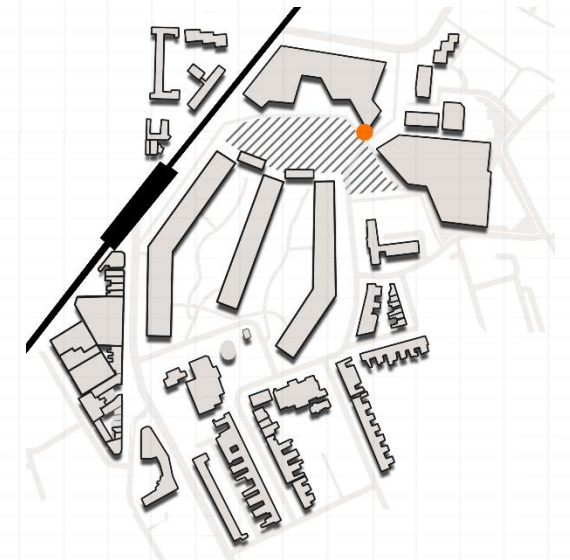

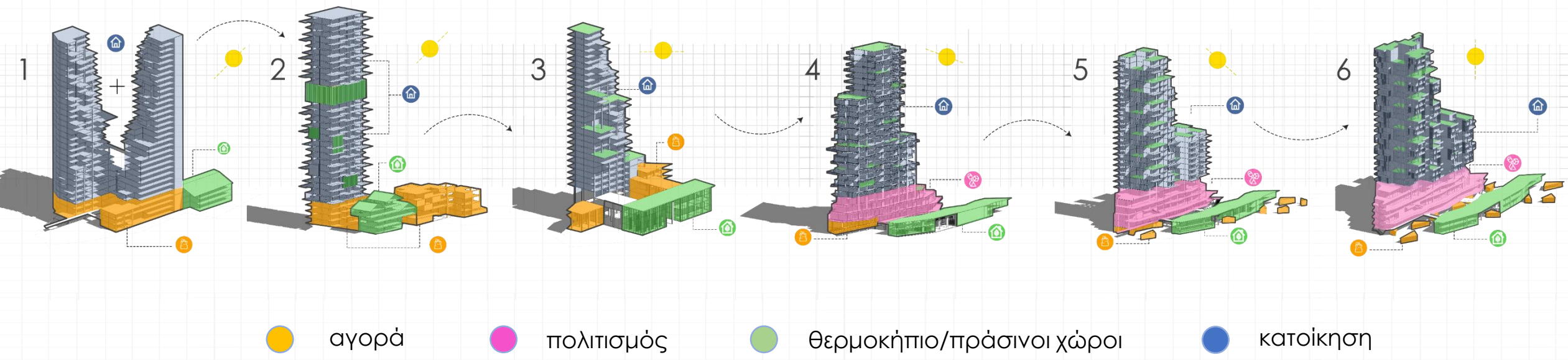



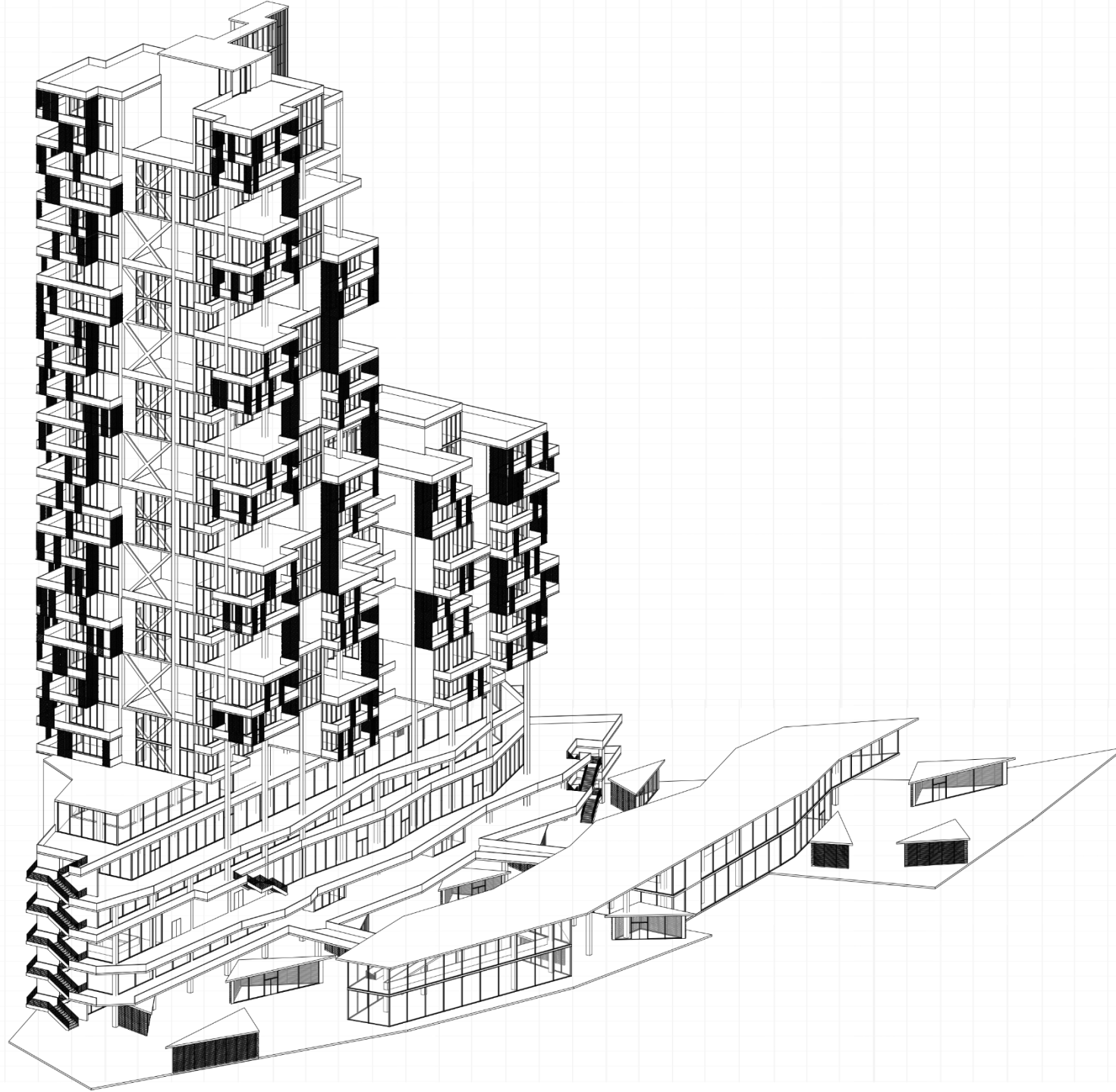

δημόσιο

A vertical village in Grenfell Tower

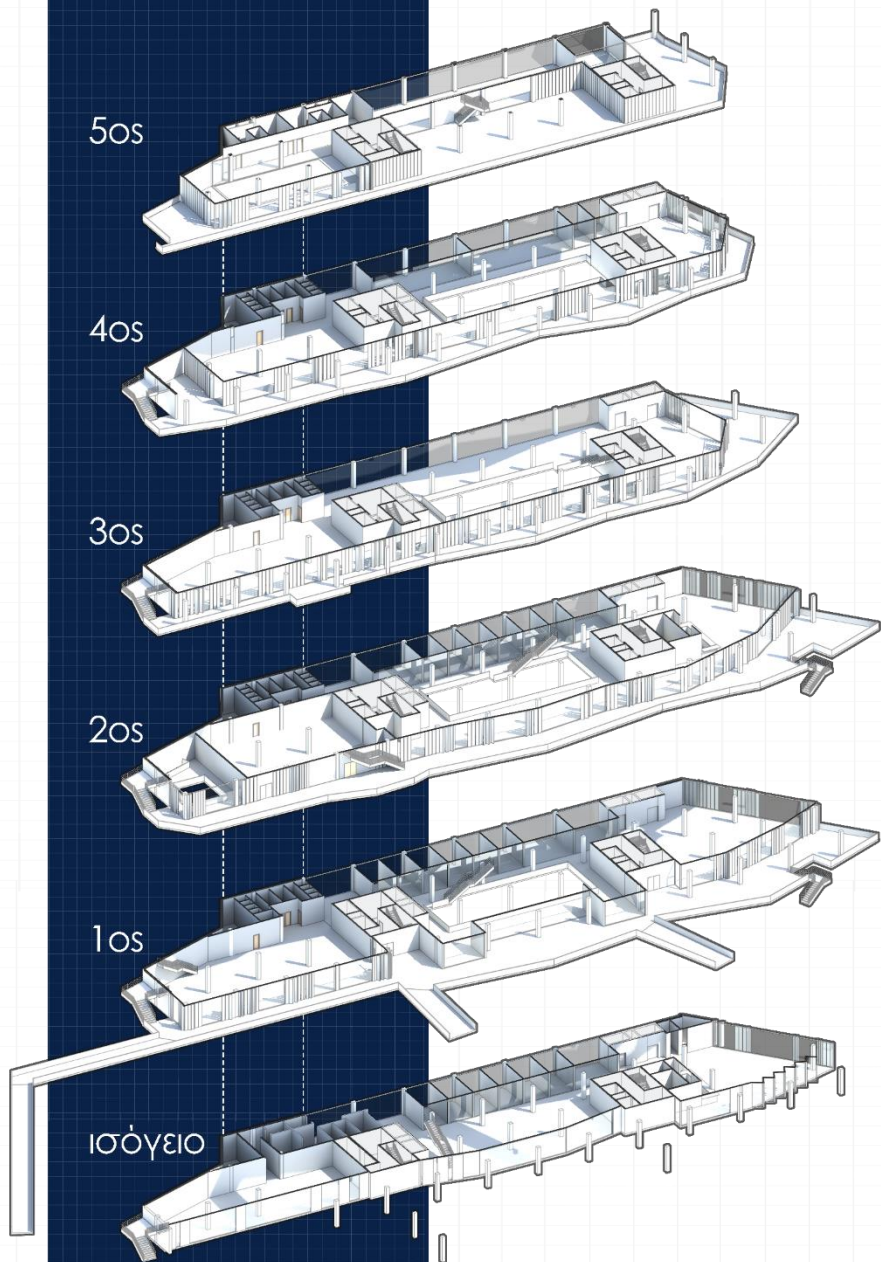

Θερμοκήπιο : 820 m²

Flea Market : 380 m²

Αγορά : 300 m²

Υποδοχή Πολυχώρου : 1.000 m²

Freelance Studios : 560 m²

Χώρος έκθεσης : 580 m²

Χώρος απασχόλησης παιδιών : 300 m²

Αίθουσα Πολλαπλών Χρήσεων : 330 m²

Βιβλιοθήκη - Αναγνωστήριο: 2.500 m²

Cafe : 250 m²

Εστιατόριο : 250 m²

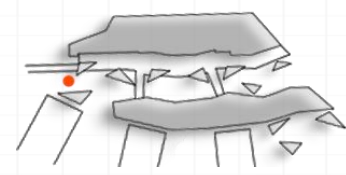

A vertical village in Grenfell Tower

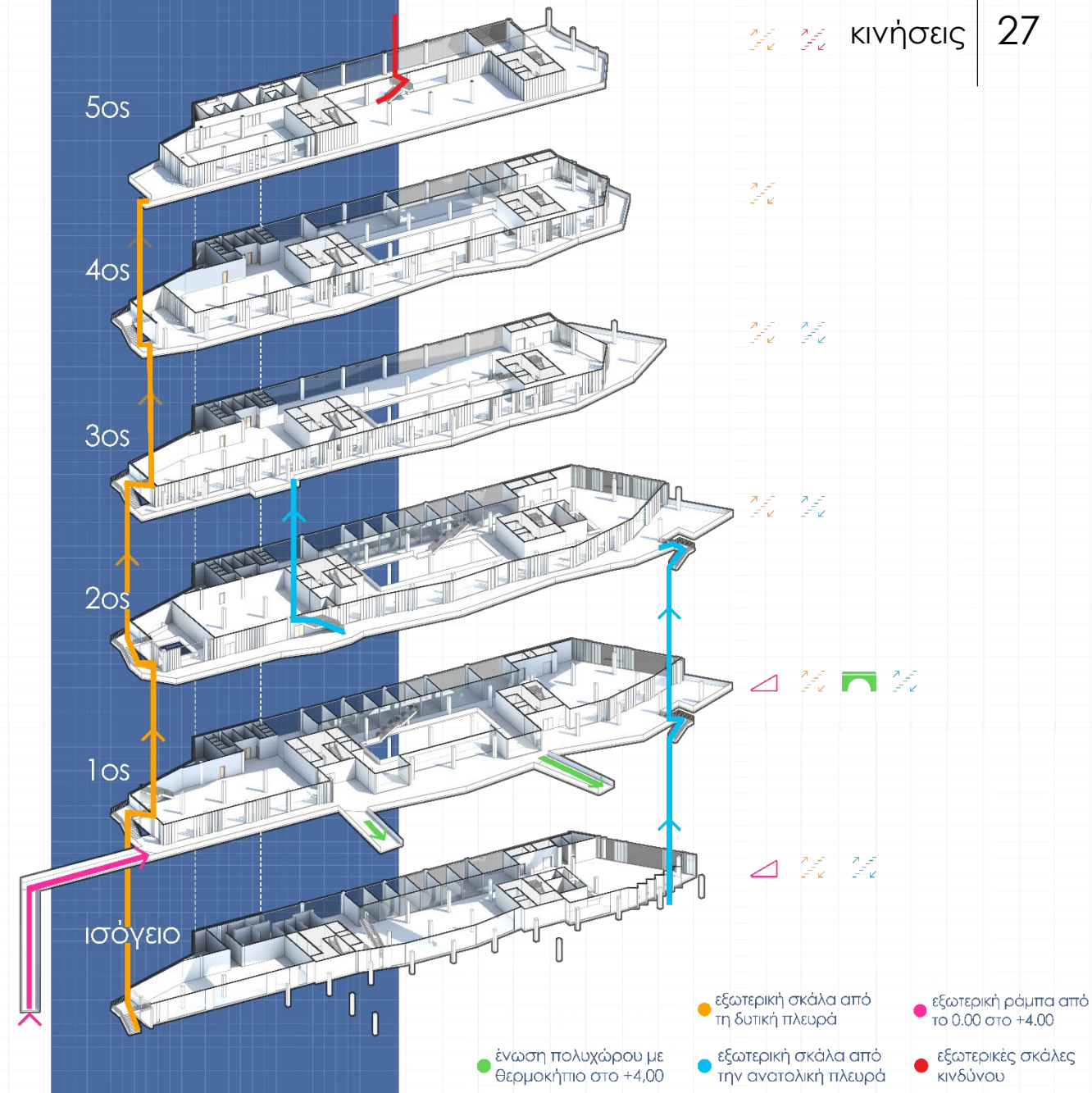
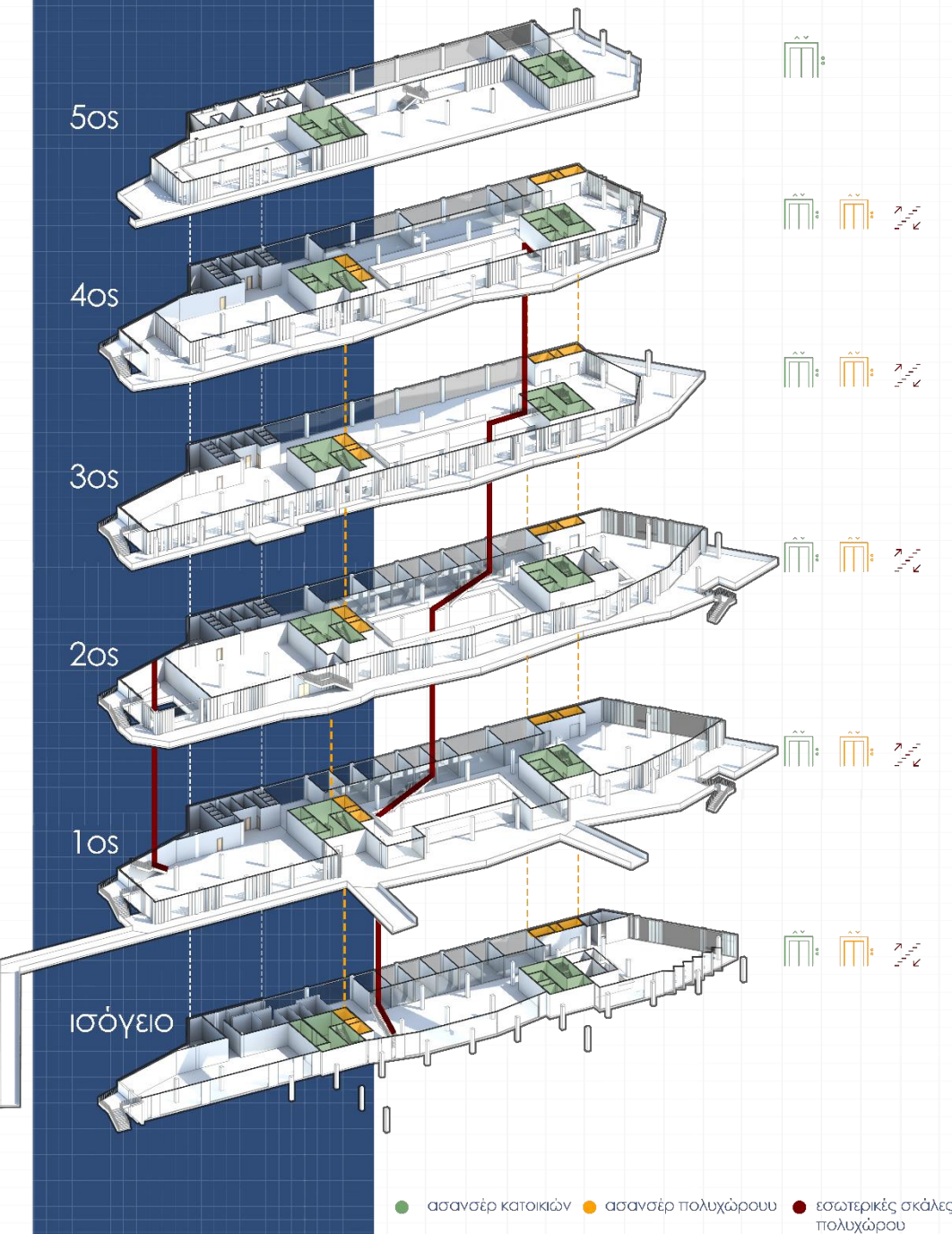

A vertical village in Grenfell Tower



A vertical village in Grenfell Tower





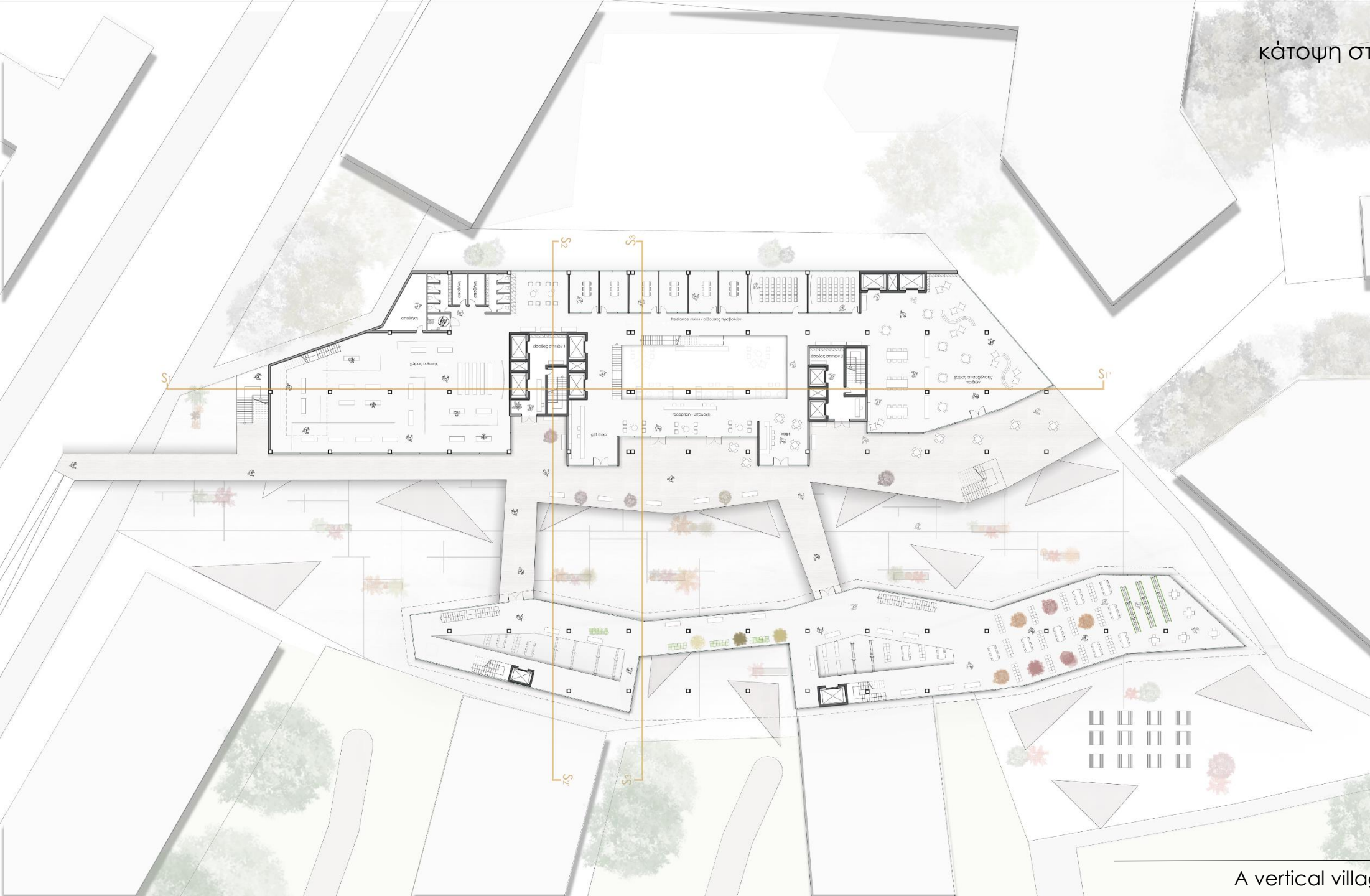



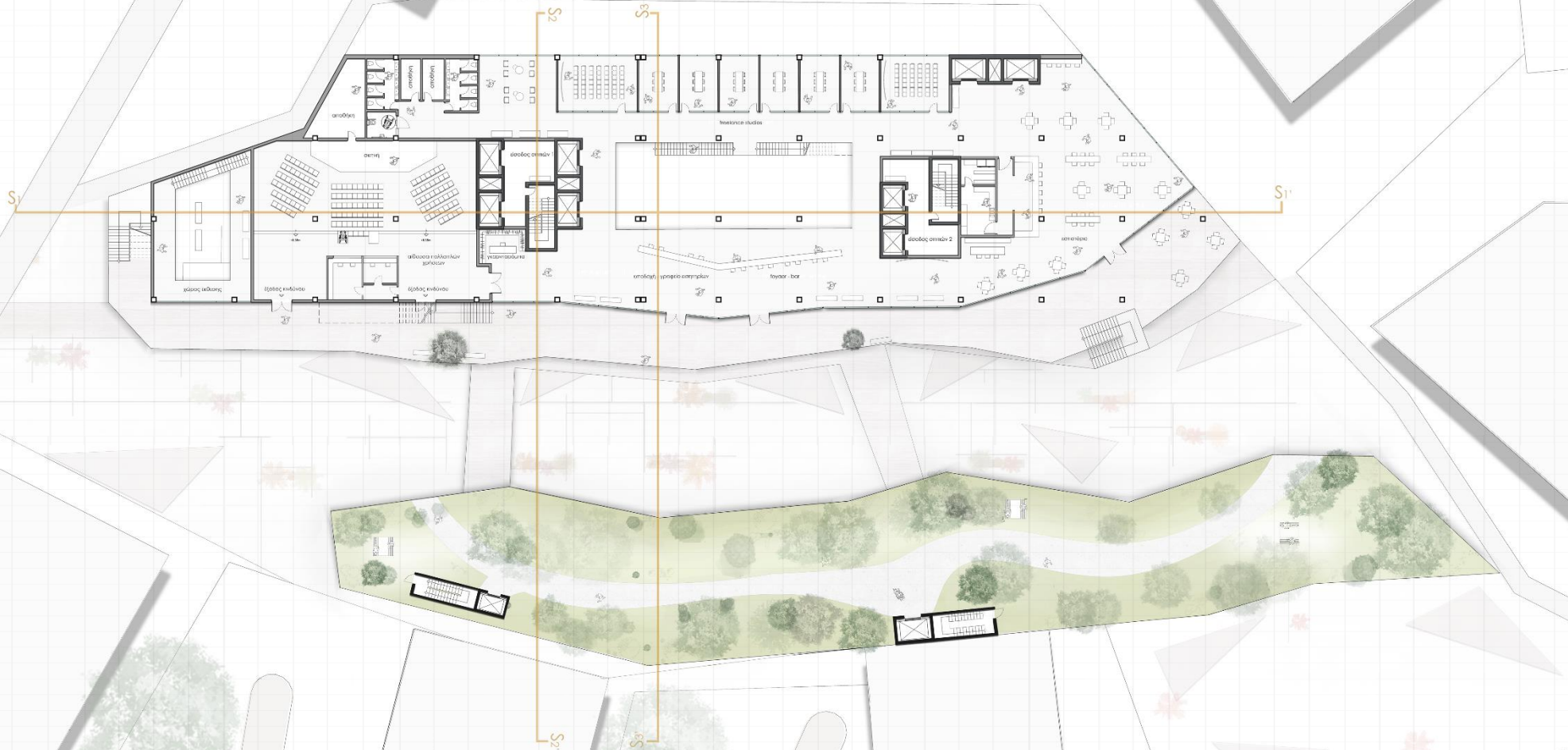



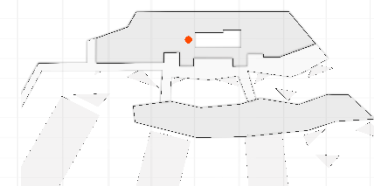

A vertical village in Grenfell Tower

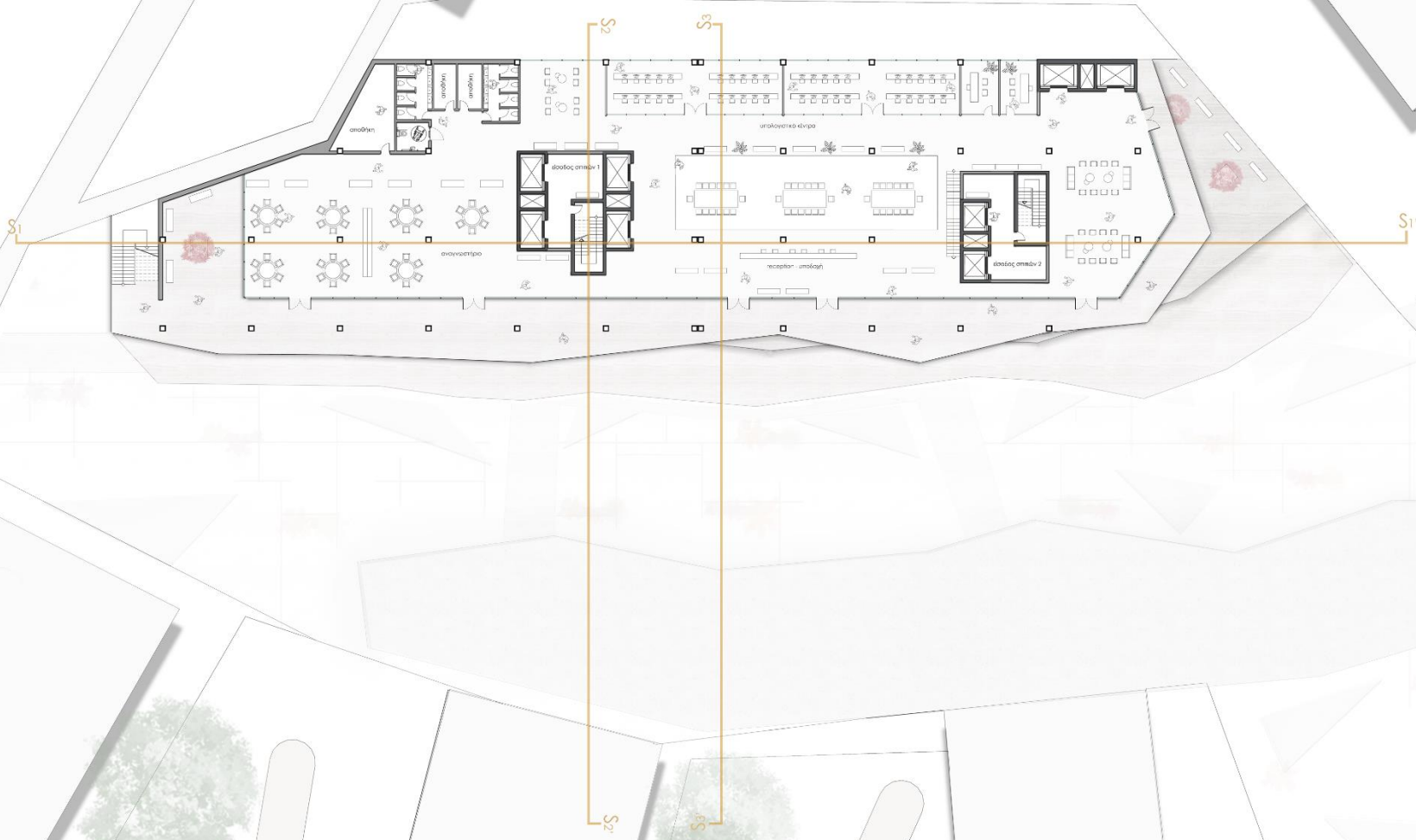

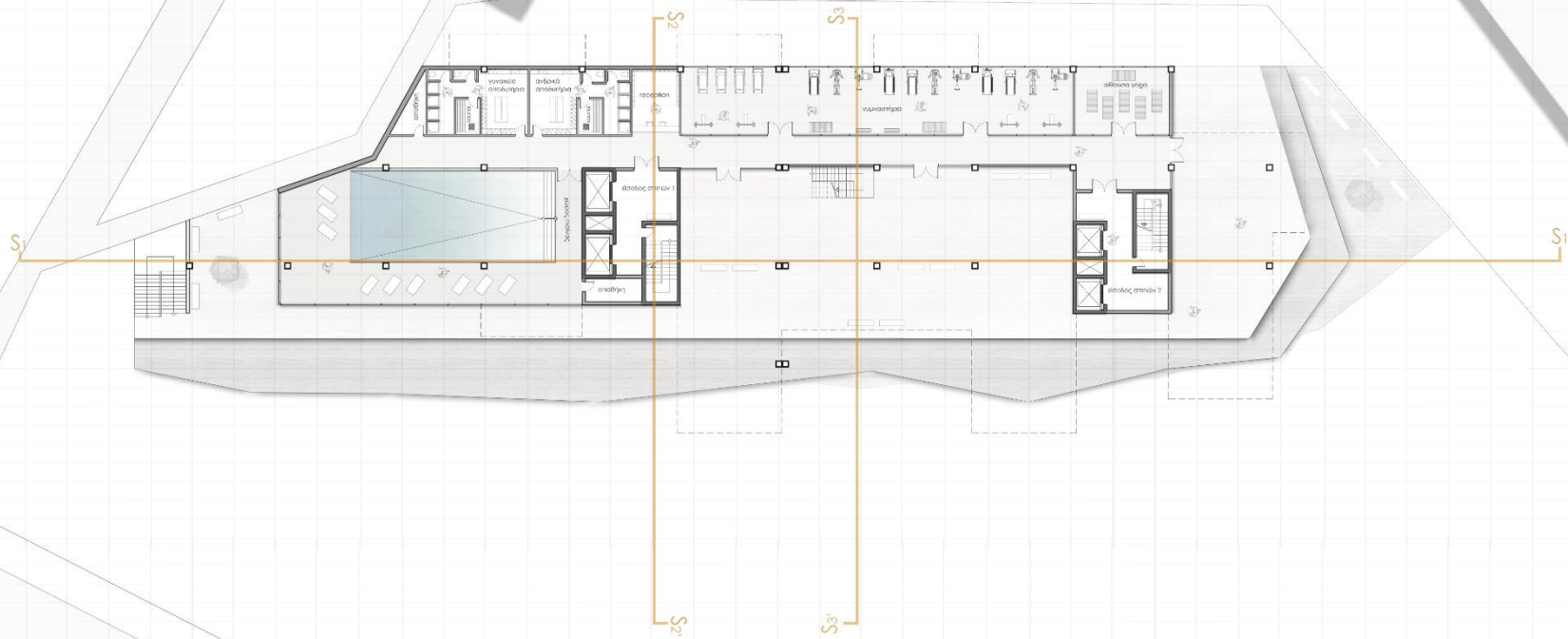



A vertical village in Grenfell Tower

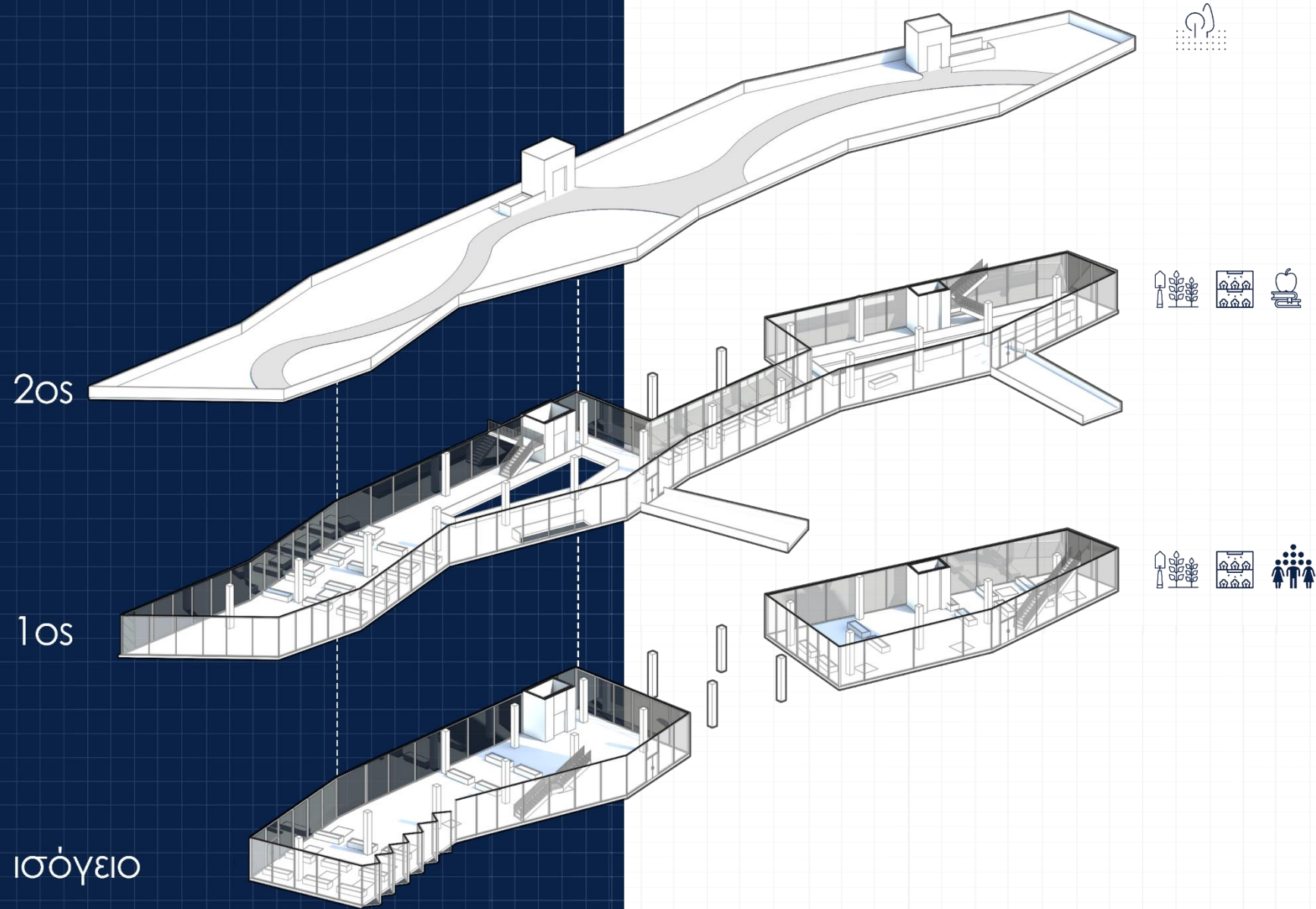

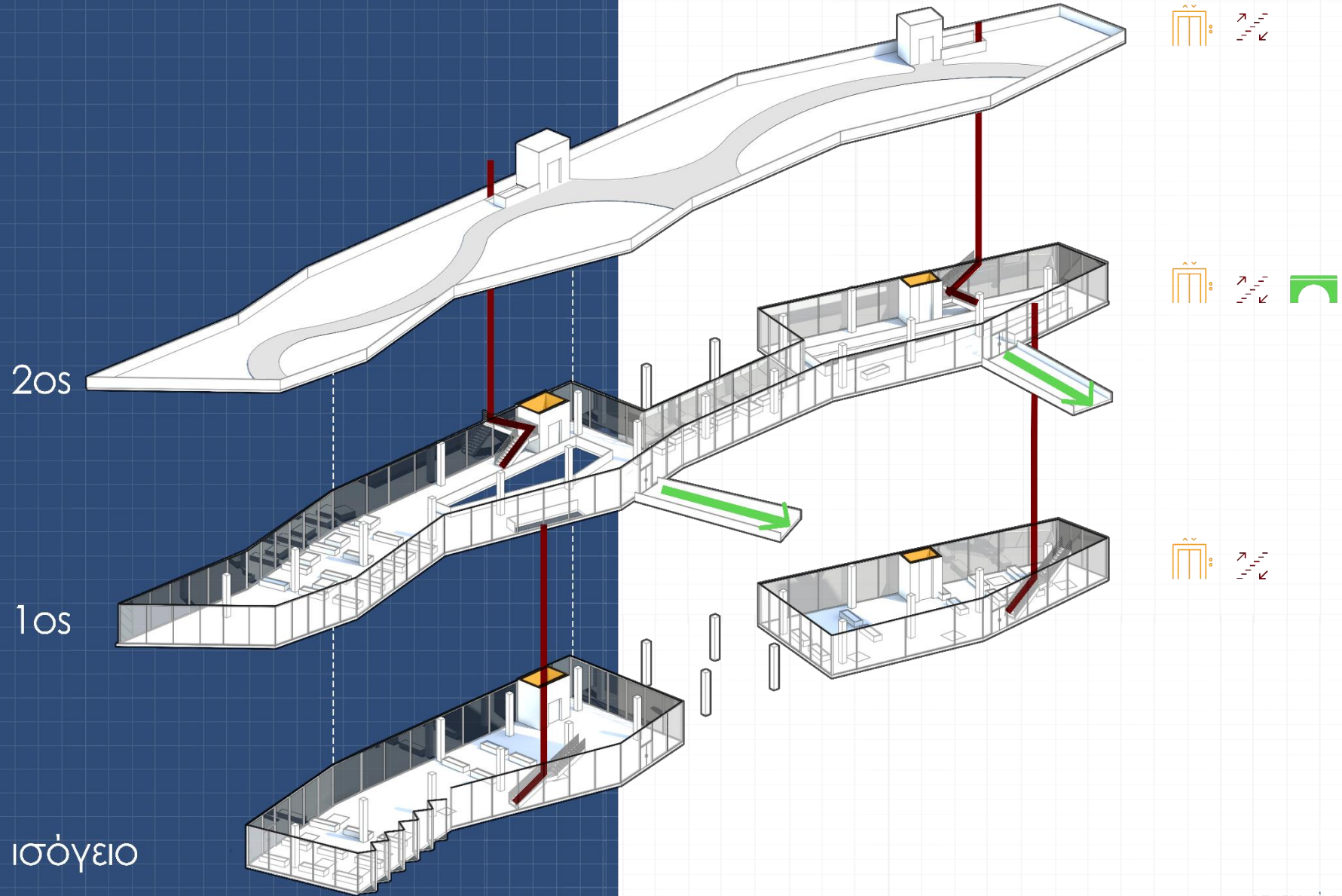

- εσωτερικά ασανσέρ θερμοκηπίου
- εσωτερικές σκάλες θερμοκηπίου
- ένωση θερμοκηπίου με πολυχώρο στο +4,00

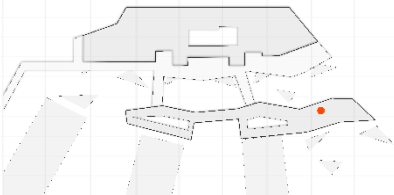

A vertical village in Grenfell Tower

Κάθετος κήπος ελαφριάς κατασκευής

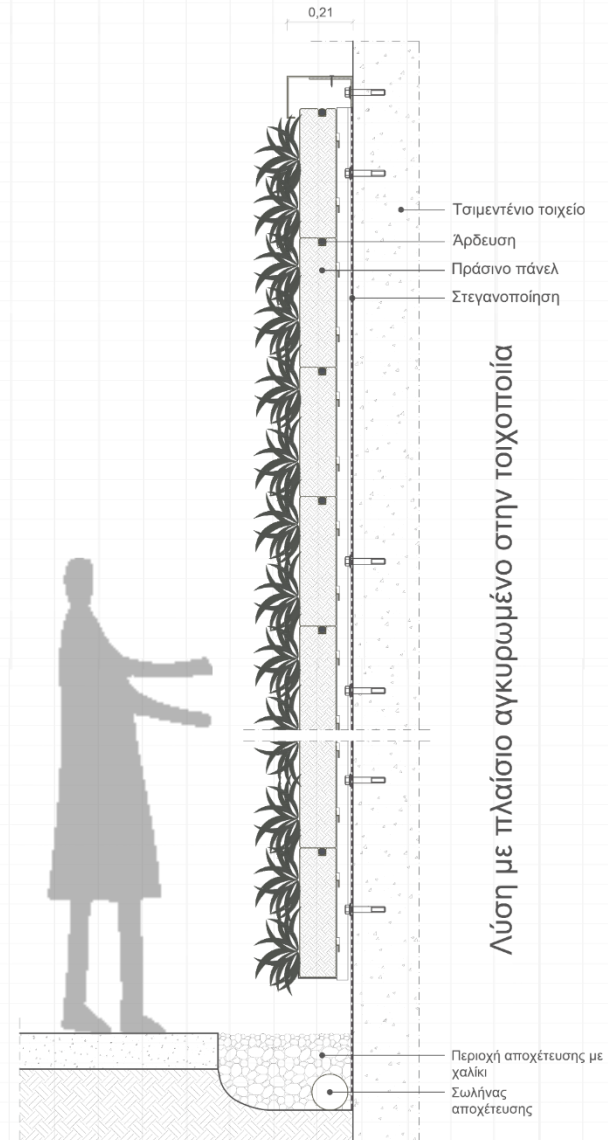
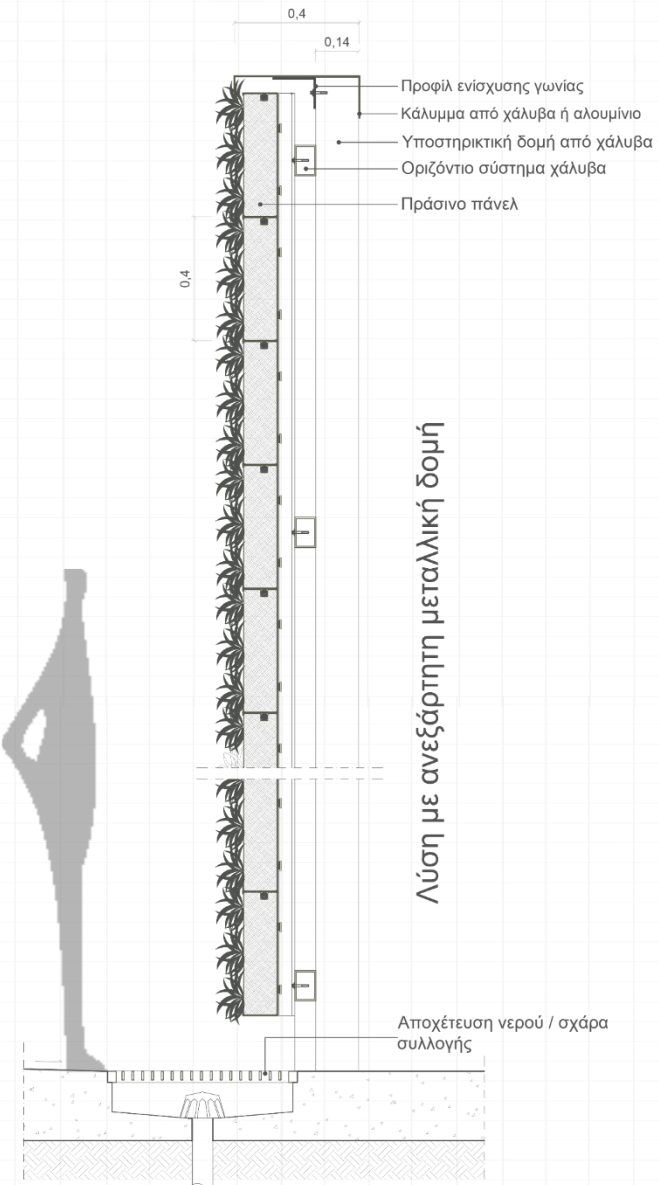

Μονή και διπλή λύση

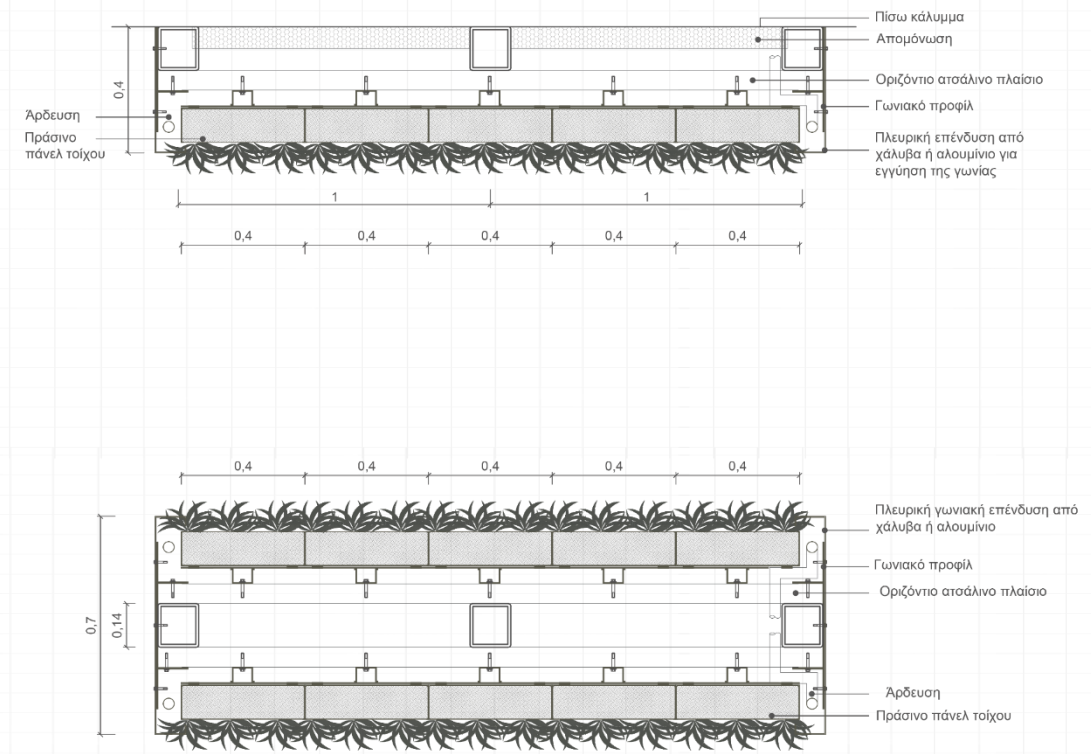

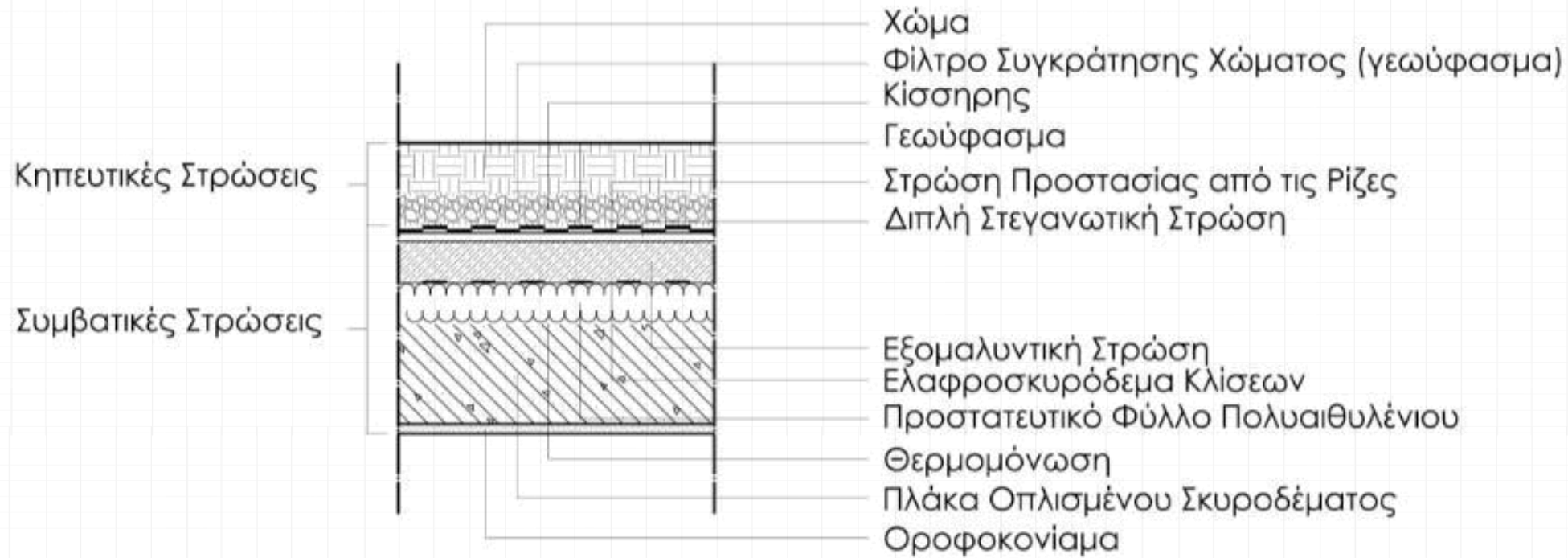

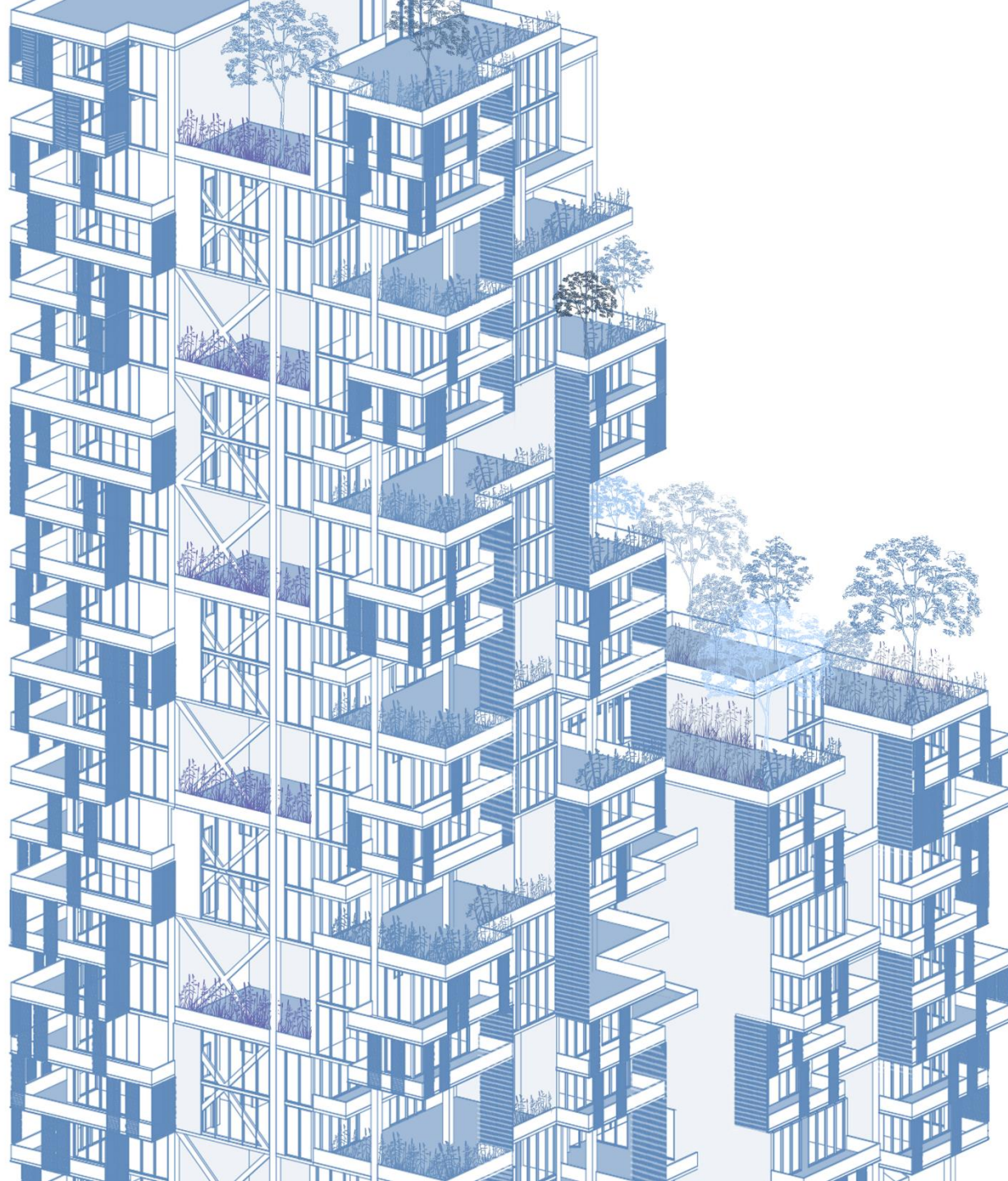

κατοικία

A vertical village in Grenfell Tower



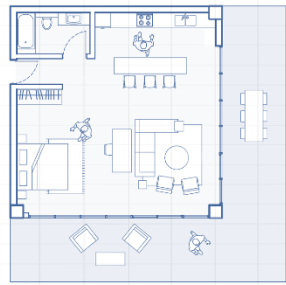

τύπος Α

- 60 τμ
- 1 κρεβατοκάμαρα
- 1 μπάνιο
- κουζίνα
- σαλόνι
- αποθήκη

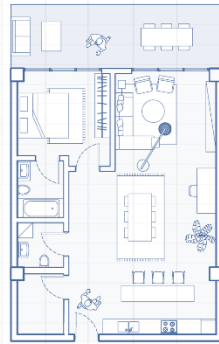

τύπος Β

- 80 τμ
- 1 κρεβατοκάμαρα
on suite
- 1 μπάνιο
- κουζίνα
- σαλόνι
- αποθήκη

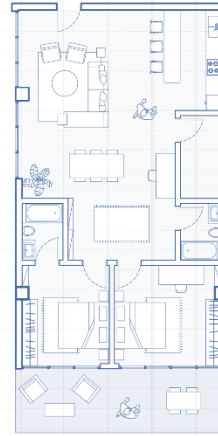

τύπος Γ

- 100 τμ
- 1 κρεβατοκάμαρα
on suite
- 1 κρεβατοκάμαρα
- 1 μπάνιο
- κουζίνα
- σαλόνι
- αποθήκη

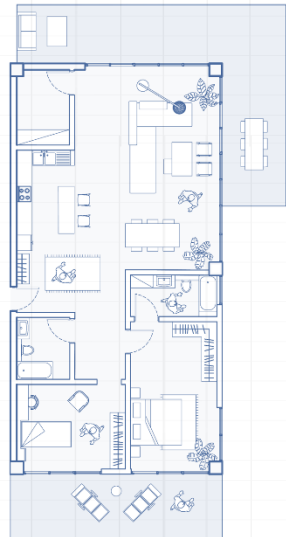

τύπος Δ

- 120 τμ
- 1 κρεβατοκάμαρα
on suite
- 1 κρεβατοκάμαρα
- 1 μπάνιο
- κουζίνα
- σαλόνι
- αποθήκη

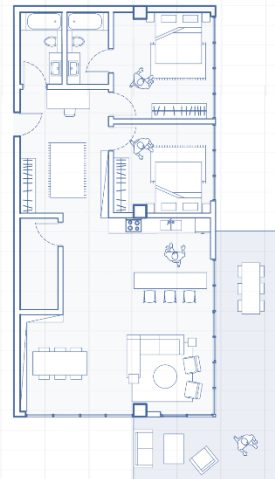

τύπος Δ₂

- 120 τμ
- 1 κρεβατοκάμαρα
on suite
- 1 κρεβατοκάμαρα
- 1 μπάνιο
- κουζίνα
- σαλόνι
- αποθήκη

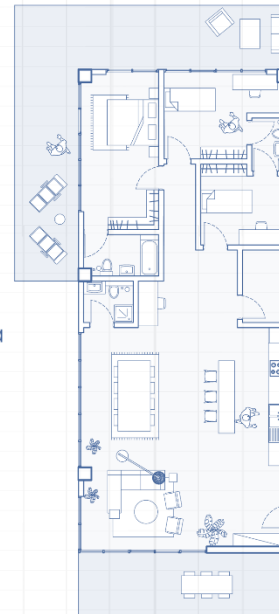

τύπος Ε

- 140 τμ
- 3 κρεβατοκάμαρες
on suite
- 1 μπάνιο
- κουζίνα
- σαλόνι
- αποθήκη



90 Μονάδες : 9.800 m²
 6 x 60 m²
 18 x 80 m²
 14 x 100 m²
 22 x 120 m²
 16 x 140 m²



Κοινόχρηστοι Κήποι : 4.160m²



Κυκλοφορία : 4.000 m²



Μπαλκόνια : 3.000 m²



Έξοδοι Κινδύνου : 1.230 m²



Γυμναστήριο : 750 m²

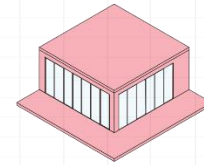
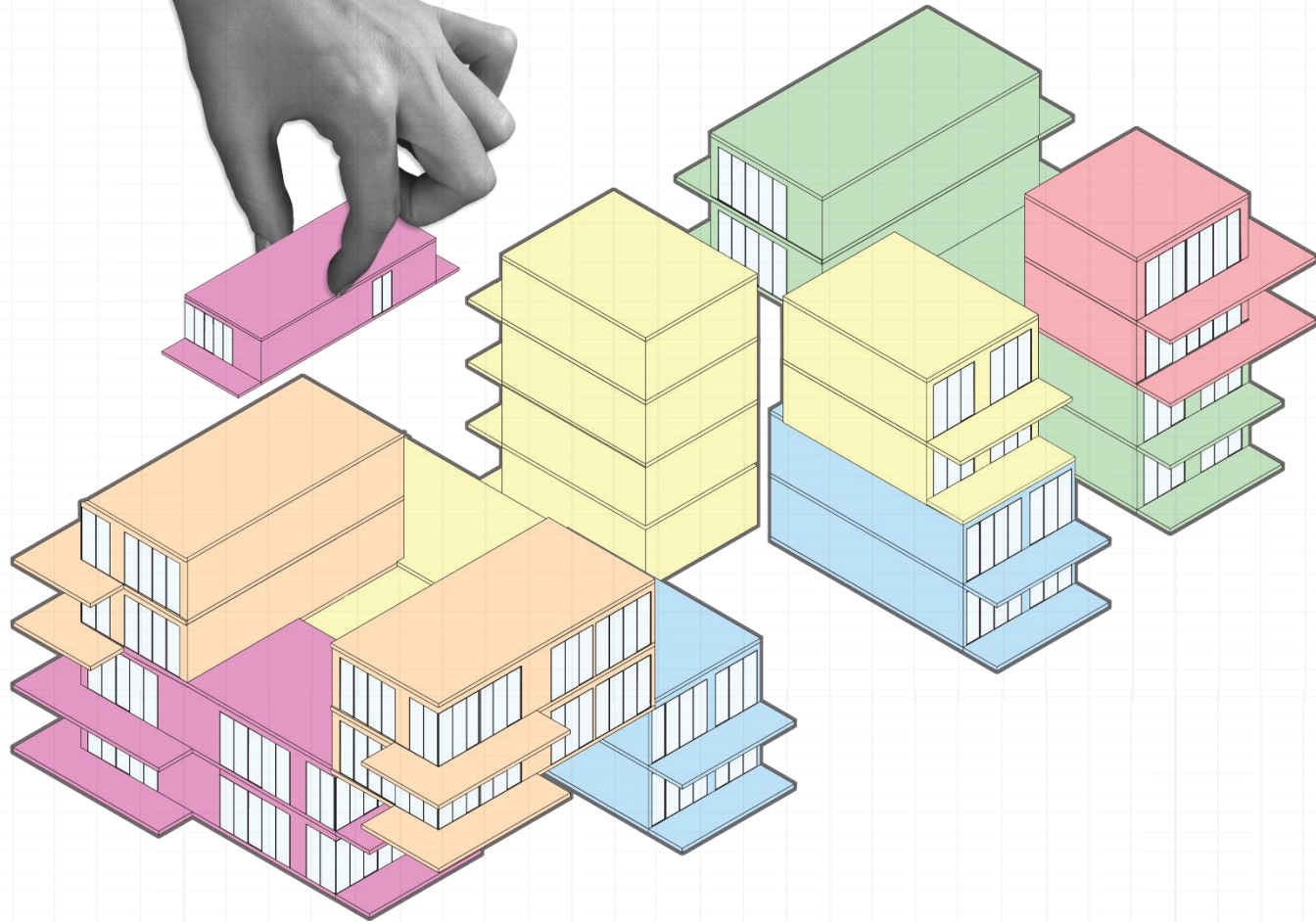

1 studio
τυπική μονάδα

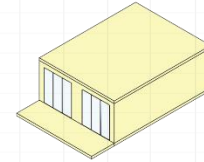

1 bedroom apt.
τυπική μονάδα

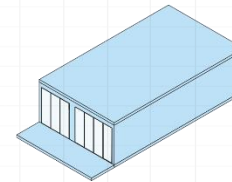

2 bedroom apt.
τυπική μονάδα 1

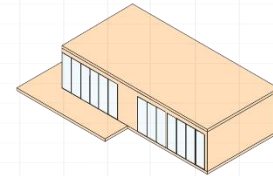

2 bedroom apt.
τυπική μονάδα 2

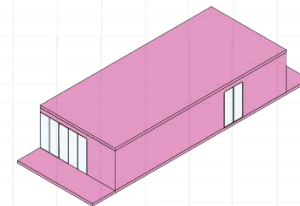

2 bedroom apt.
τυπική μονάδα 3

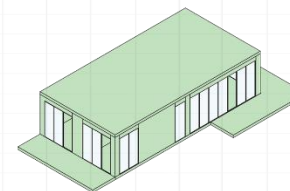

3 bedroom apt.
typical unit





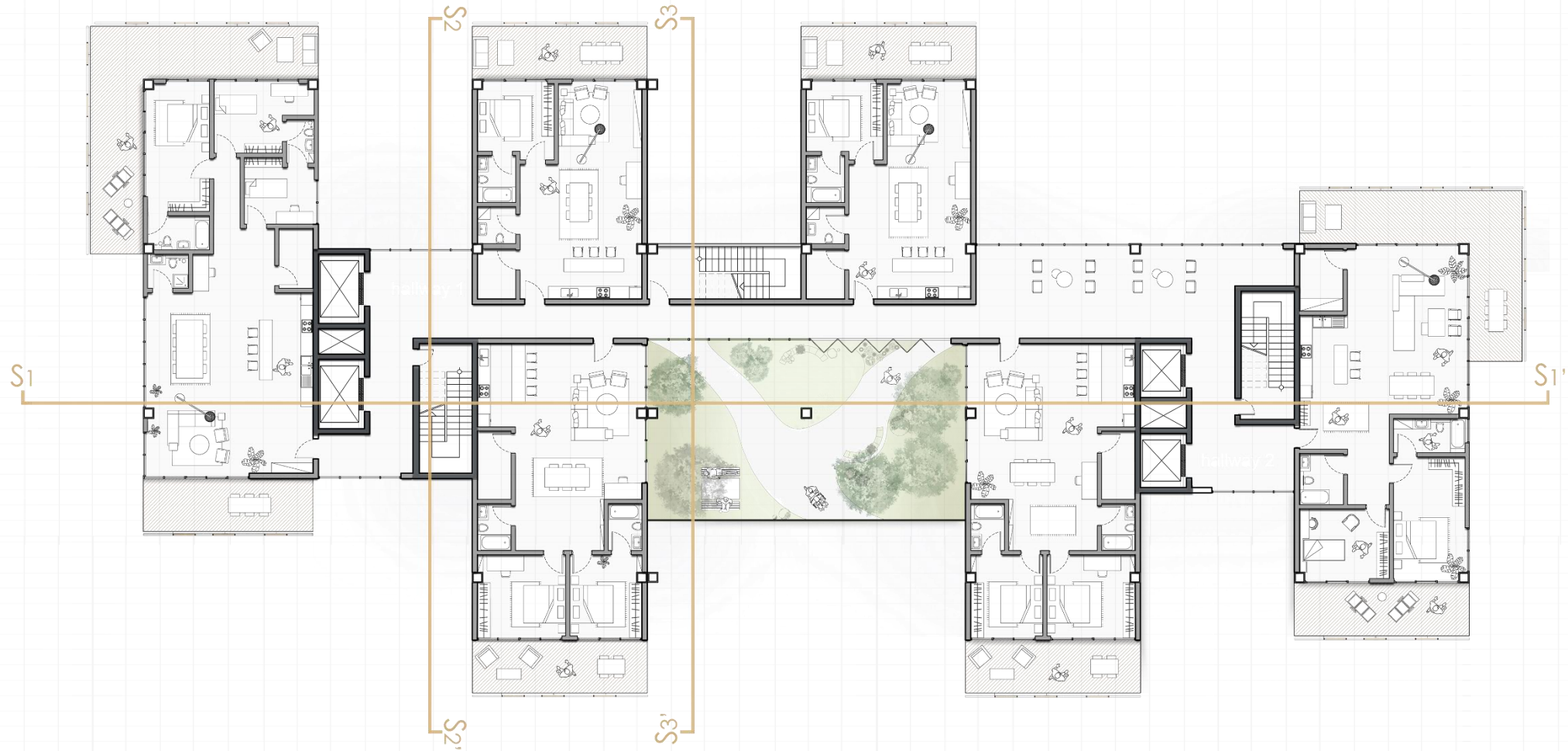

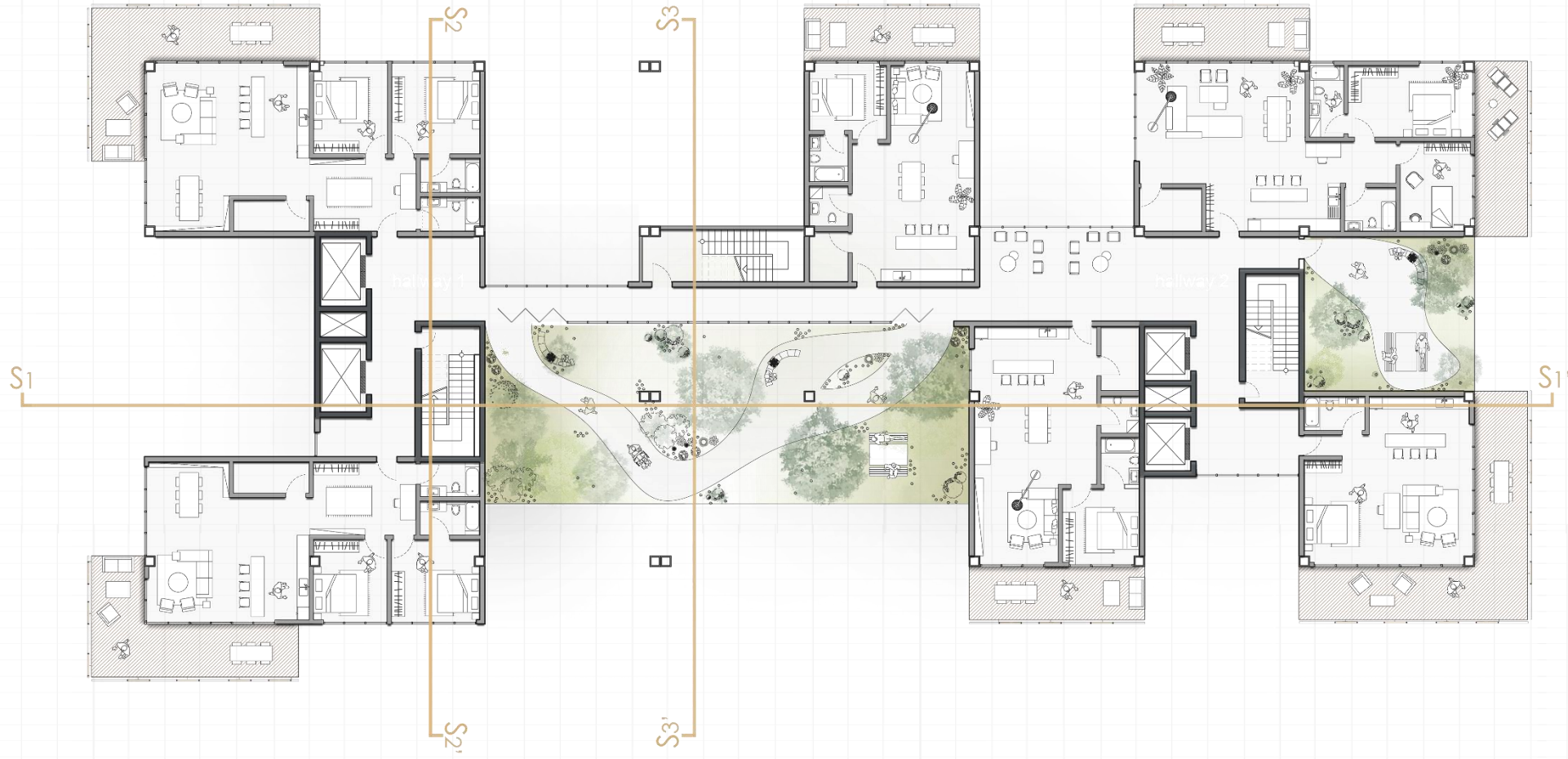



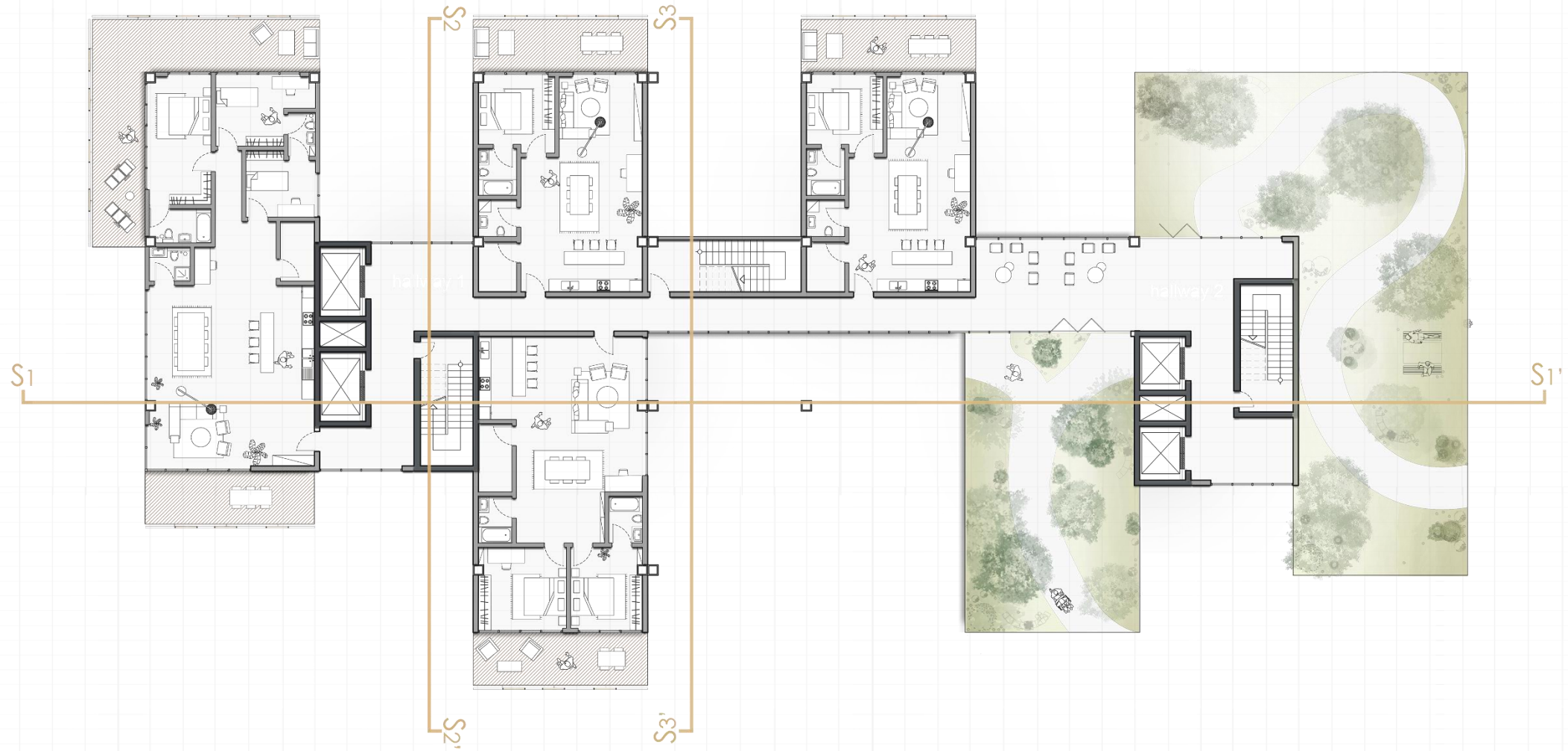

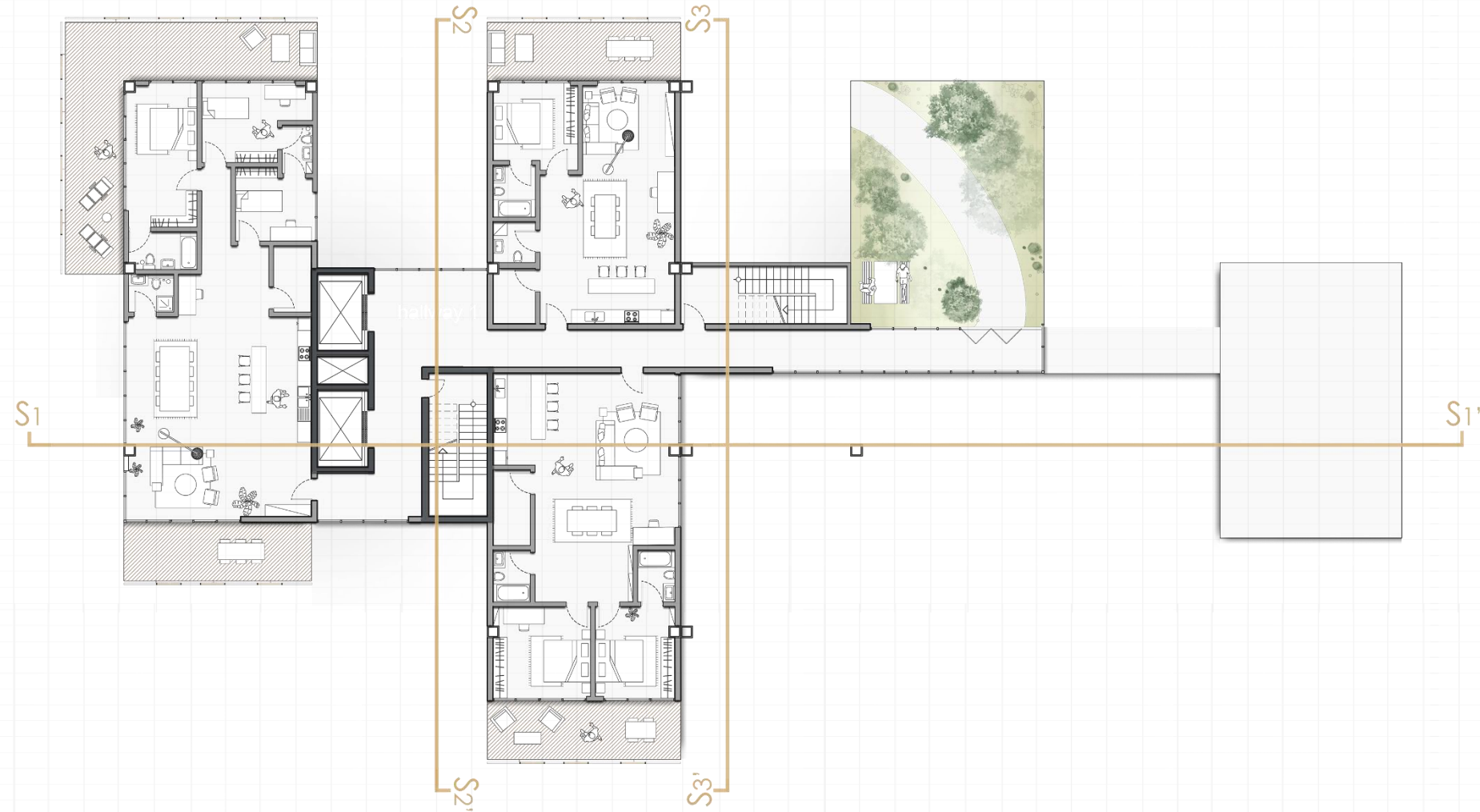



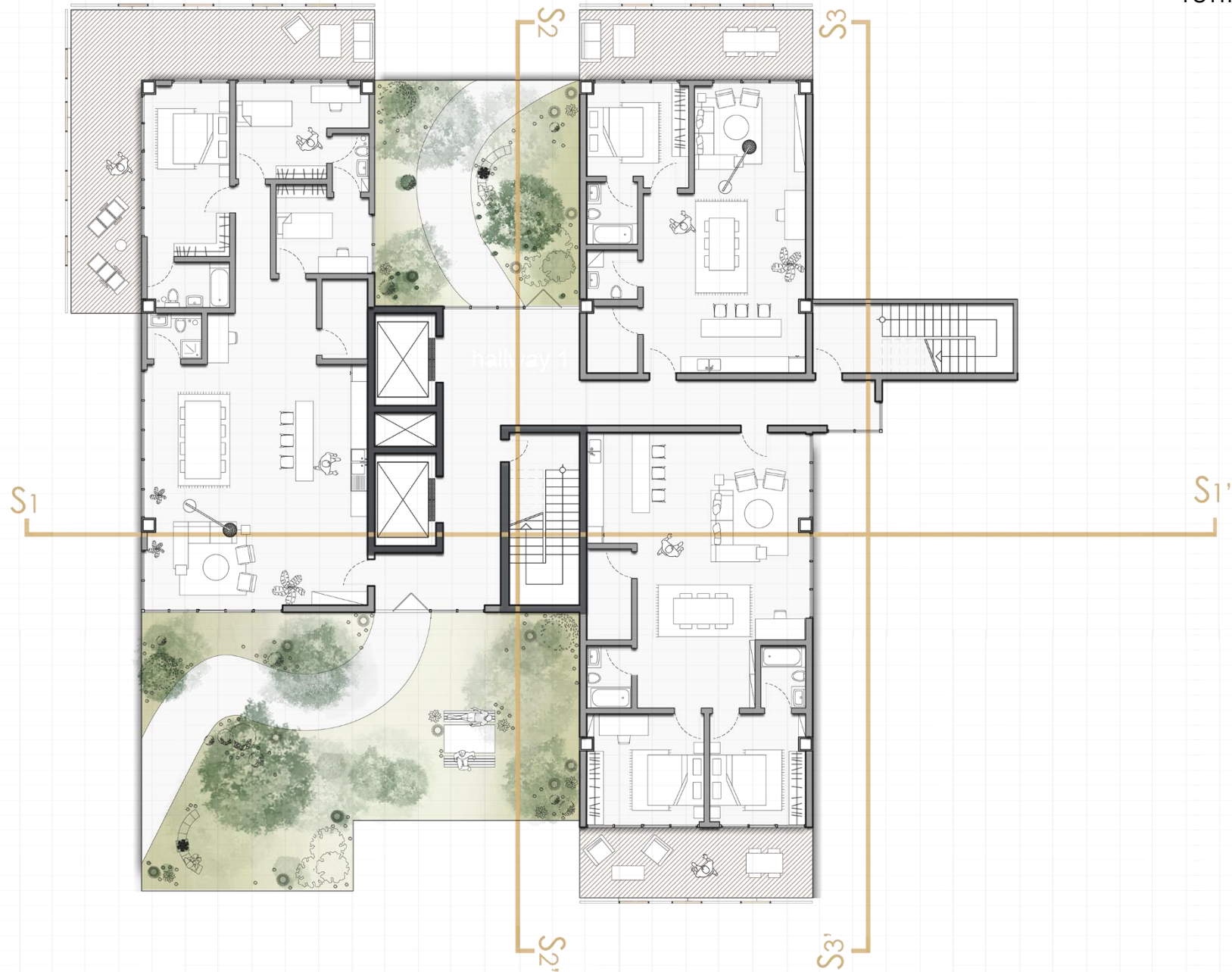

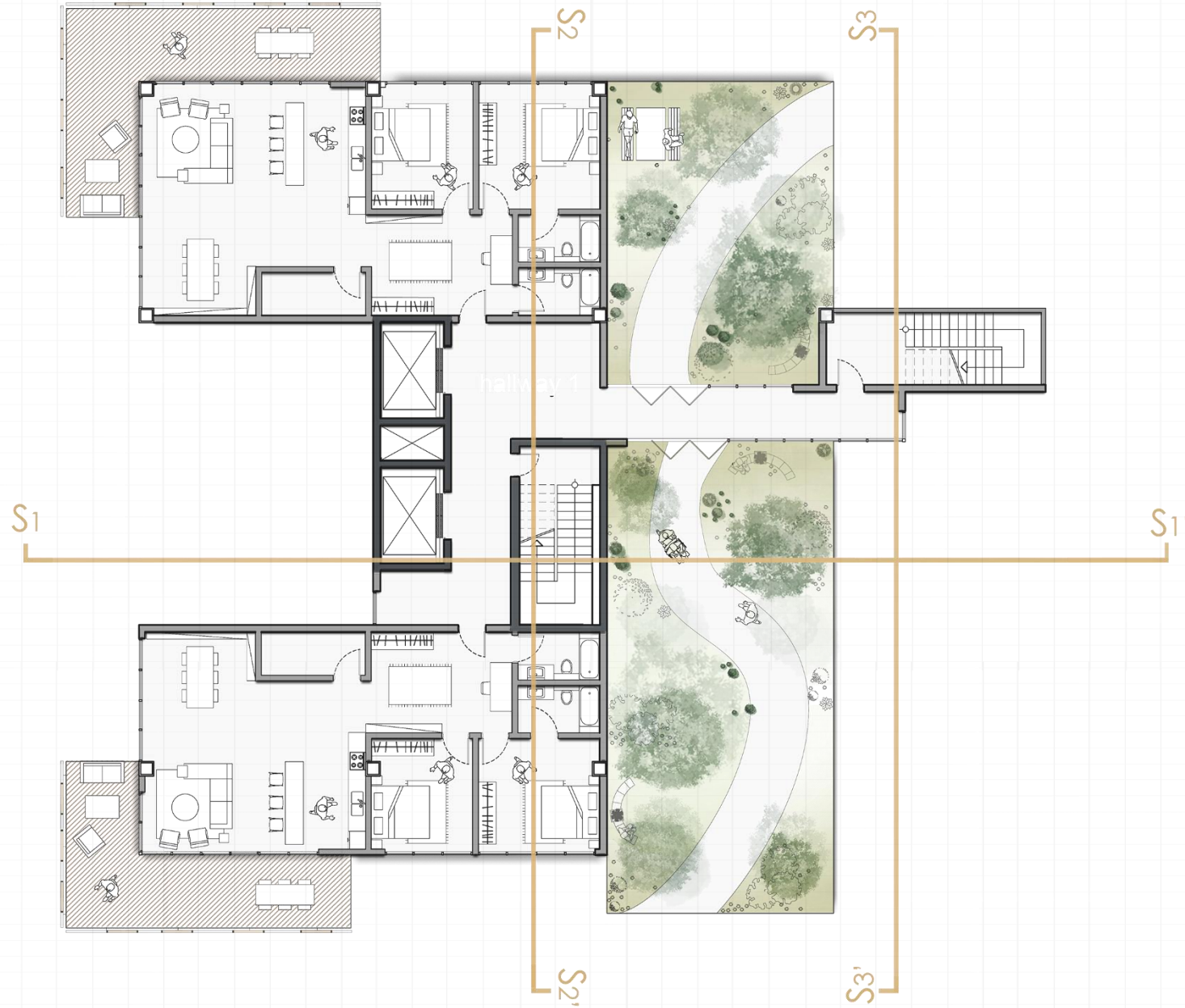



A vertical village in Grenfell Tower

ΤΟΜΕΣ - ΟΨΕΙΣ

A vertical village in Grenfell Tower

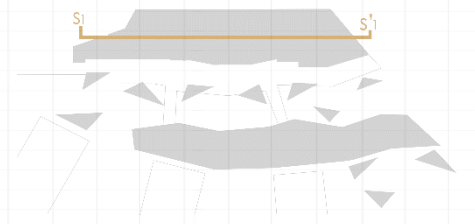
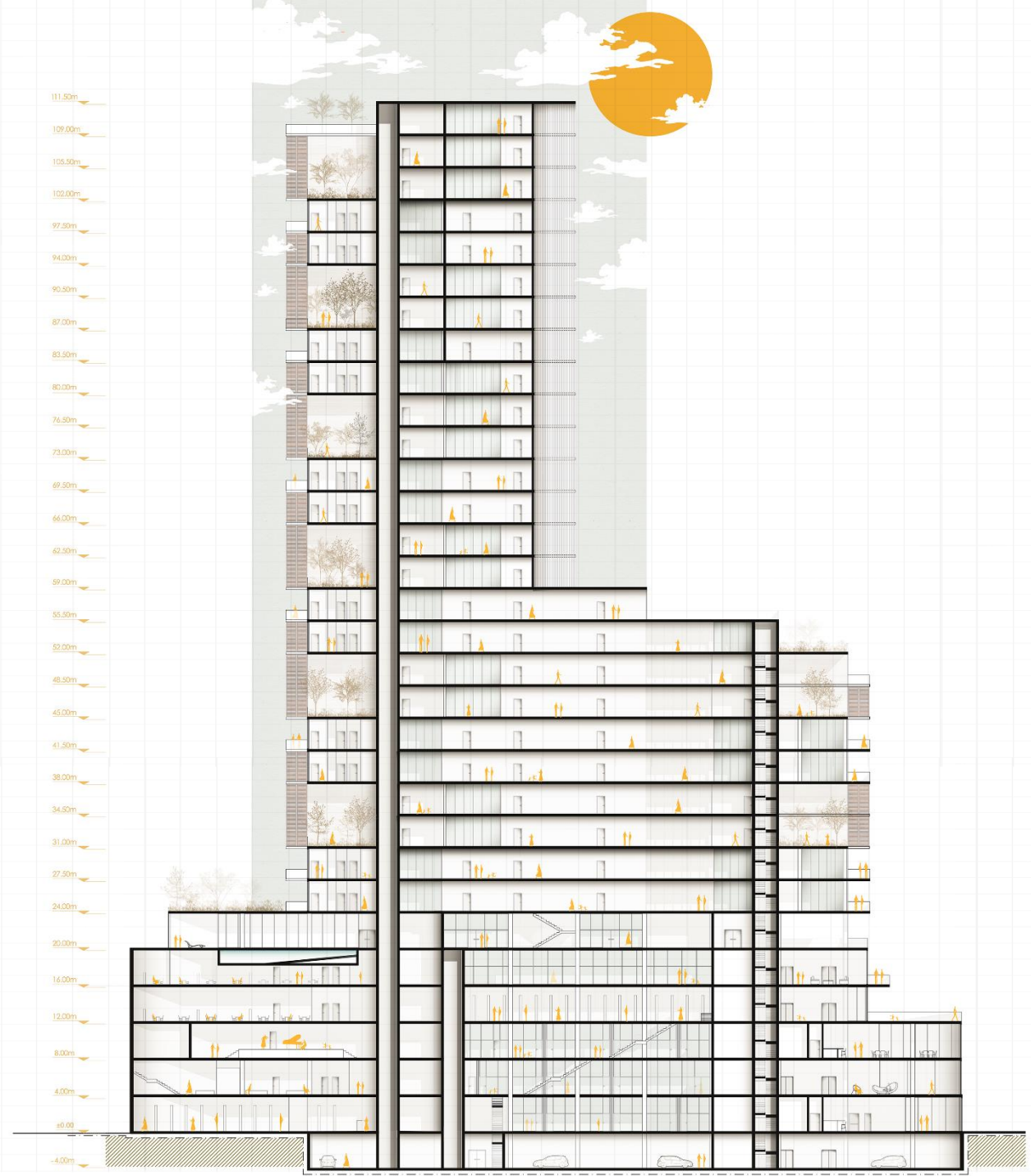

A vertical village in Grenfell Tower

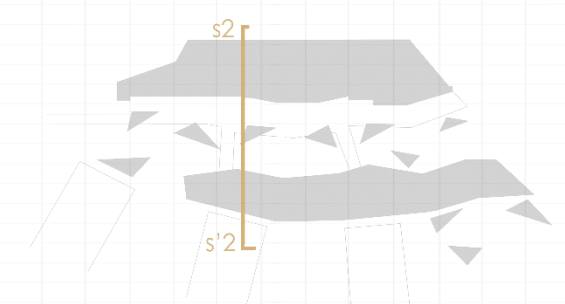
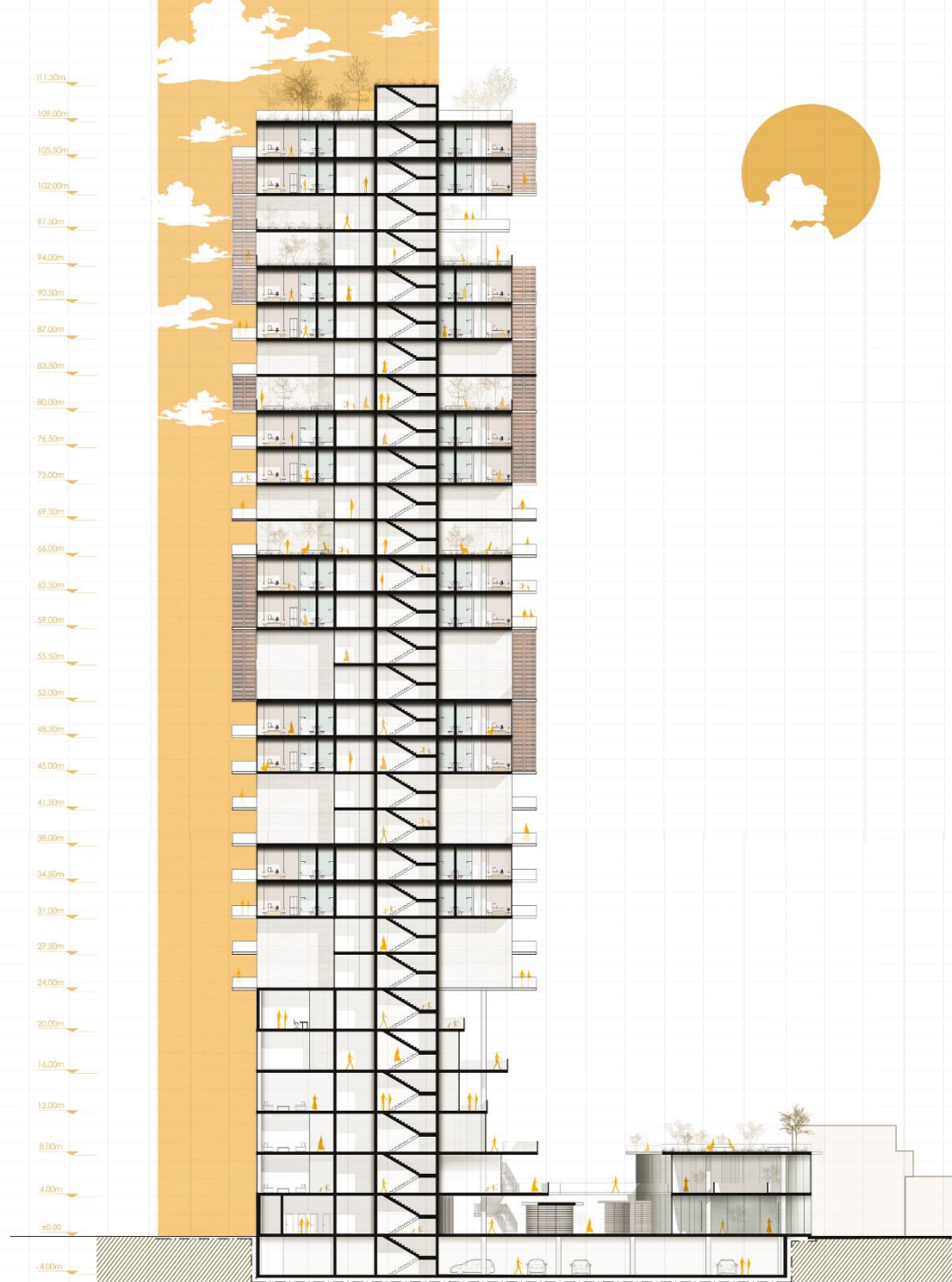

A vertical village in Grenfell Tower

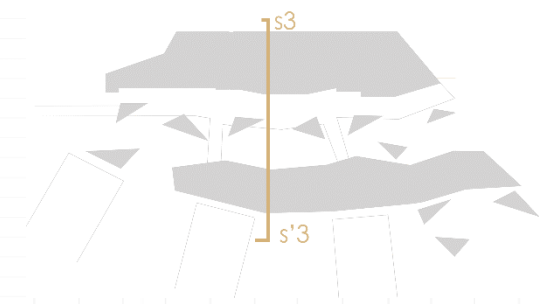
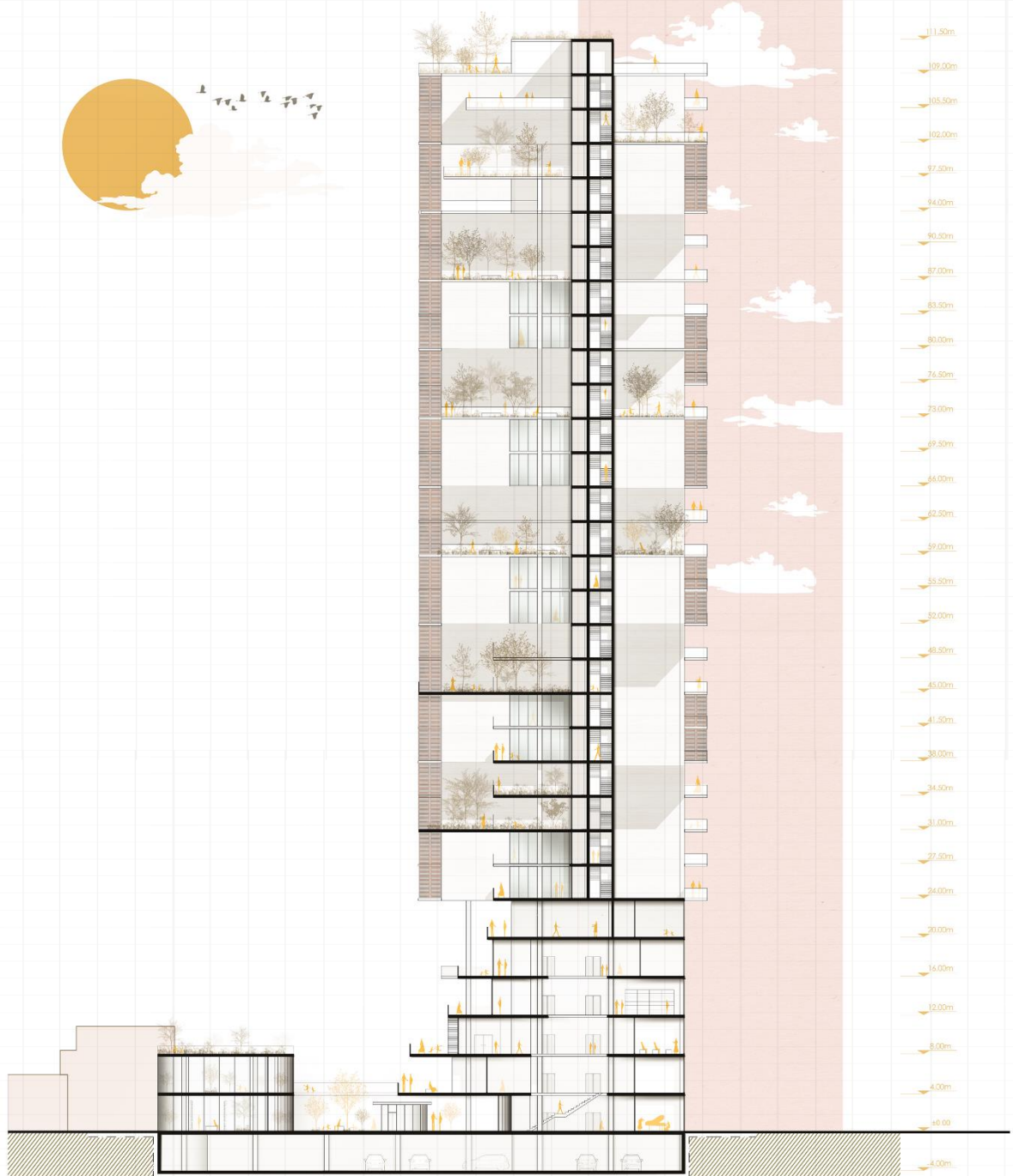

A vertical village in Grenfell Tower

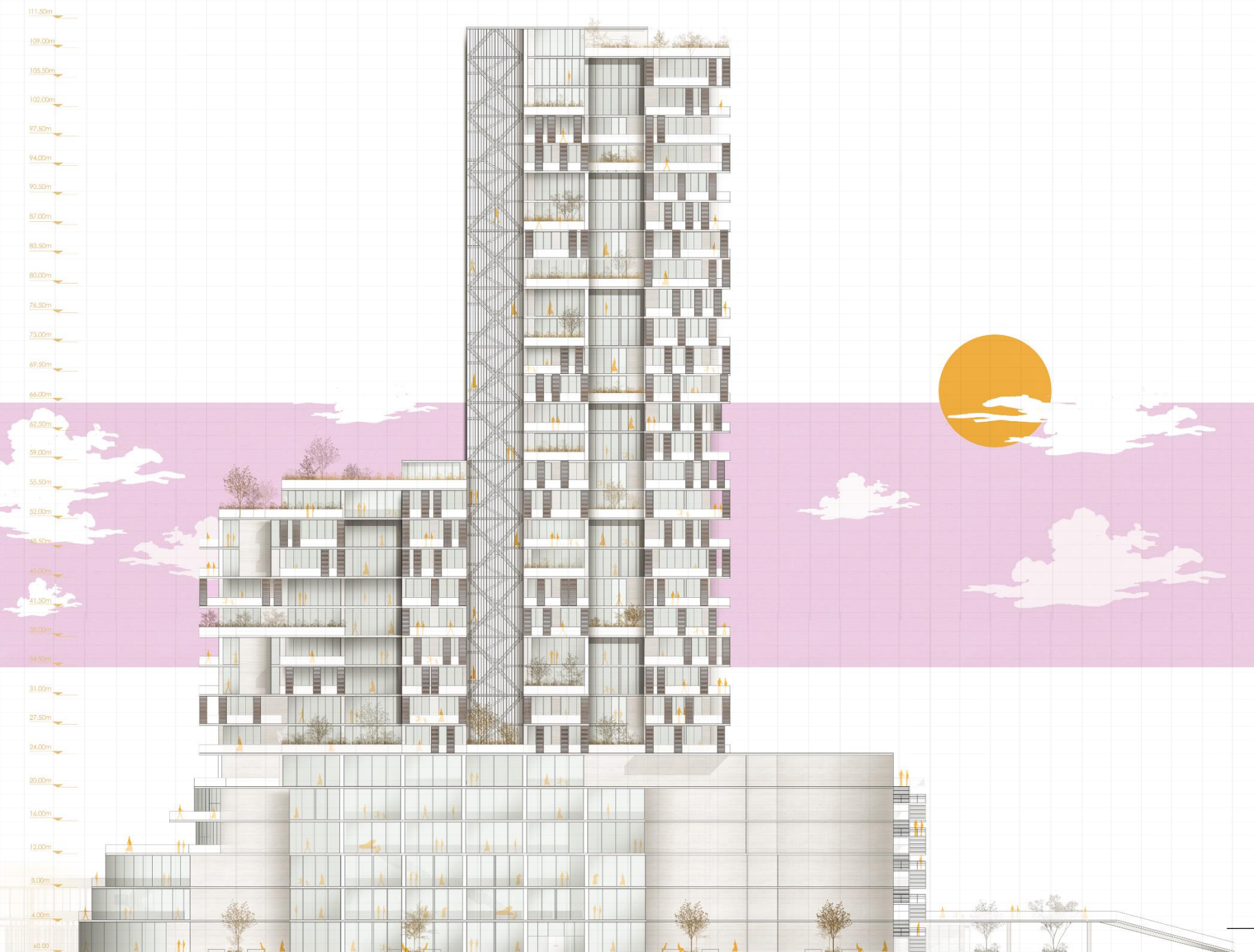

A vertical village in Grenfell Tower

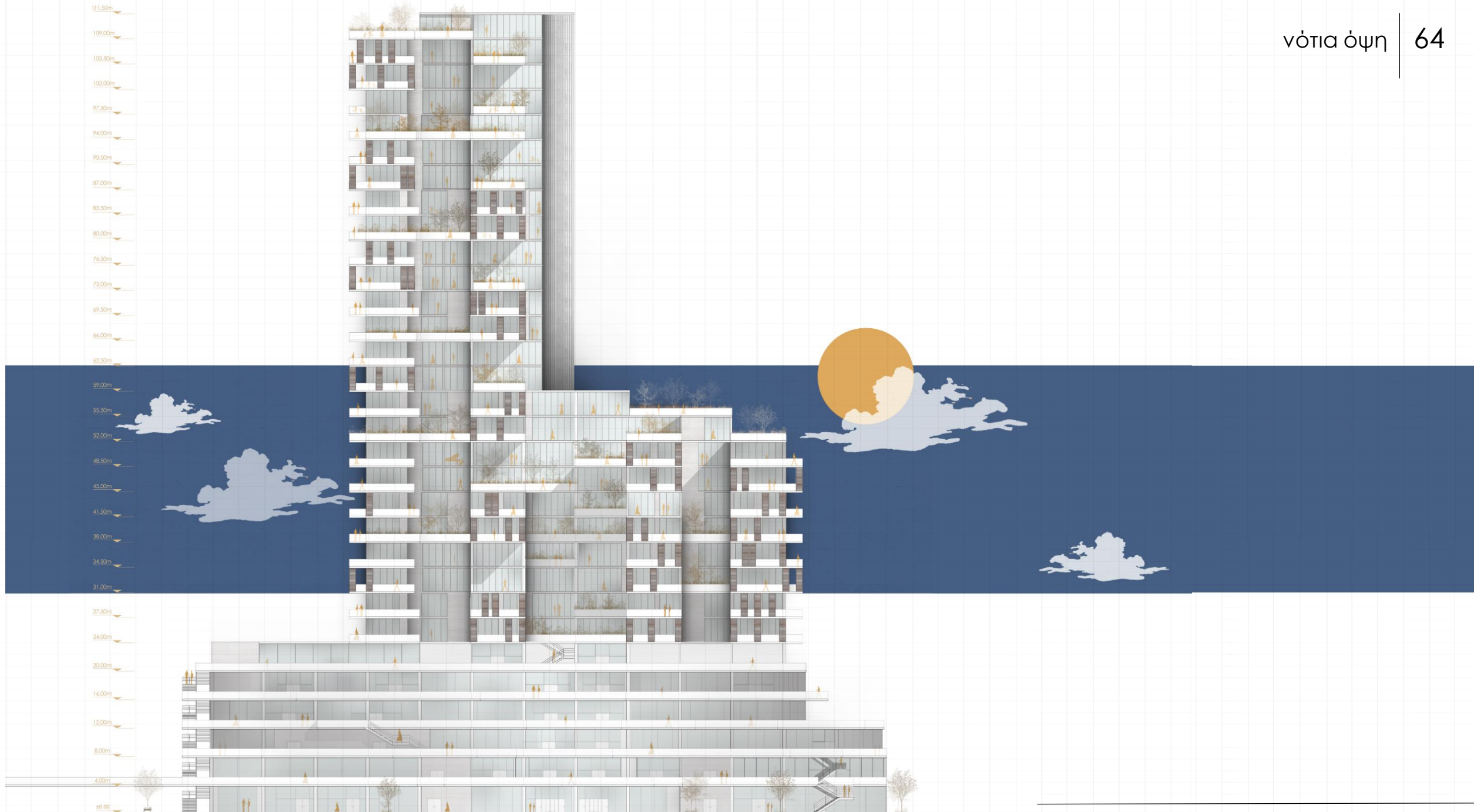

A vertical village in Grenfell Tower

μακέτα

A vertical village in Grenfell Tower



A vertical village in Grenfell Tower

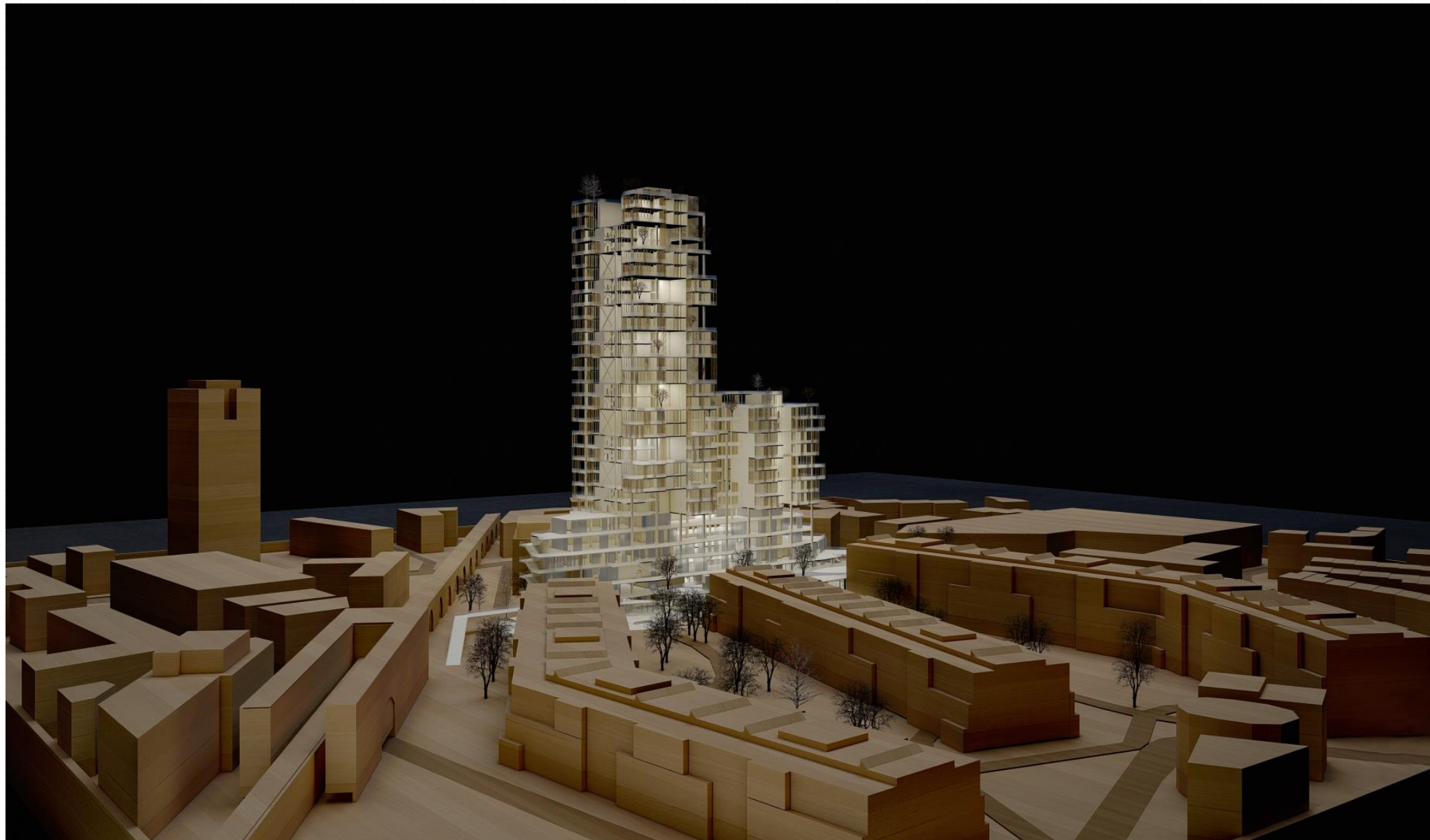

A vertical village in Grenfell Tower



A vertical village in Grenfell Tower



...forever in our hearts.

Ευχαριστούμε